

9010
novantadieci[®]



Indice prodotti / Products Index
Produktindex / Indice Produits

4

Azienda / Company
Unternehmen / Entreprise

6

Materiale / Material
Material / Matériel

10

Designer

16

A parete / Wall lighting
Wandleuchten / Appliques

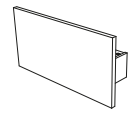

1090 p. 102

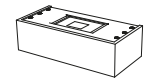

1091 p. 106

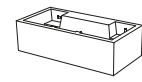

1091B p. 110



1091C p. 110

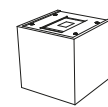

1092 p. 114

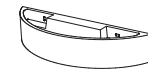

1095B p. 126

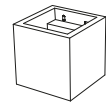

1096B p. 130

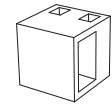

1096C p. 130

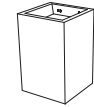

1097 p. 134

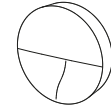

1098 p. 96

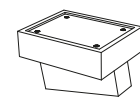

1104A+Q p. 76

A plafone / Ceiling lighting
Deckenleuchten / Plafonniers

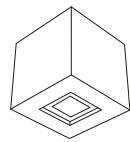

1094 p. 122

Segnapassi / Pathmarkers
Orientierungsbeleuchtung / Balisages

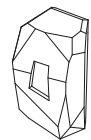

1102 p. 40

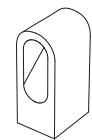

1105A p. 70

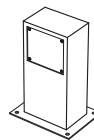

1111A p. 138

Paletti / Bollard
Pollerleuchten / Bornes

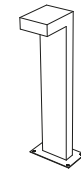

1093 p. 118

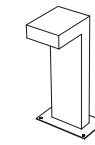

1093B p. 118



1103A p. 34

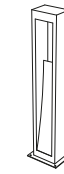

1103B p. 30

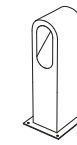

1105B p. 70



1105C p. 70



1106A+Q p. 82



1107 p. 24

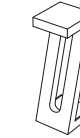

1108A p. 60



1108B p. 60



1109 p. 50

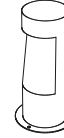

1110A p. 92

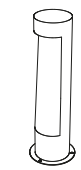

1110B p. 92

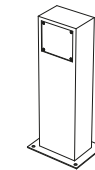

1111B p. 138

Numeri civici / House numbers
Hausnummern / Numéros de maison

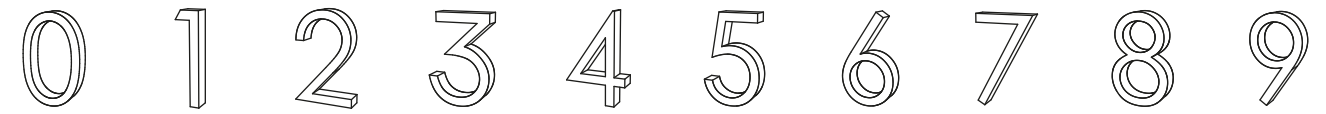

p. 144

Accessori / Accessories
Zubehöre / Accessoires

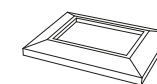

1103K p. 148

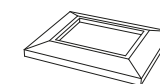

1105K p. 148



1106K p. 148



1110K p. 148

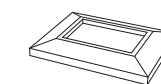

1111K p. 148

We are light creators

Da mezzo secolo ideiamo, progettiamo e realizziamo lampade e sistemi di illuminazione per spazi interni e da oggi anche esterni. La nostra profonda conoscenza delle materie prime, unita alla passione, alla creatività e all'amore per il nostro lavoro sono le caratteristiche che ci rendono unici.

EN For half a century we have conceived, designed and manufactured lamps and lighting systems for interiors and - as of now - exteriors too. Our profound understanding of raw materials, along with our passion, creativity and love for our work, are what makes us truly unique.

DE Seit einem halben Jahrhundert entwerfen, entwickeln und fertigen wir Leuchten und Beleuchtungssystem für den Innenbereich und ab jetzt auch für den Außenbereich. Unsere tiefe Kenntnis der Rohstoffe, verbunden mit der Leidenschaft, der Kreativität und der Liebe zu unserer Arbeit sind die Eigenschaften, die uns einzigartig machen.

FR Depuis un demi-siècle, nous imaginons, concevons et réalisons des lampes et systèmes d'éclairage d'intérieur et désormais aussi d'extérieur. Notre profonde connaissance des matières premières, allée à la passion, à la créativité et à la passion pour notre travail sont les caractéristiques qui nous rendent unique.



1968

A Nove, nel cuore del Veneto, viene fondata Belfiore Ceramiche Artistiche, in una zona ricca di artigianato manifatturiero sin dal Settecento.

EN In Nove, in the heart of Veneto, Belfiore Ceramiche Artistiche was founded, in an area rich in ceramic manufacturing tradition since the 18th century.

DE In Nove, mitten in Venetien, wird in einer Gegend, die seit dem 18. Jahrhundert reich an Kunsthandwerk ist, Belfiore Ceramiche Artistiche gegründet.

FR À Nove, au cœur de la Vénétie, Belfiore Ceramiche Artistiche voit le jour dans une zone réputée pour son artisanat manufacturier depuis le XVIIIe siècle.

'70

La presenza dell'azienda si afferma nel settore della ceramica tradizionale e decorativa, con prodotti dalle finiture pregiate.

EN The company becomes a well-established presence in the production of traditional and decorative ceramics, with products of precious finishes.

DE Die Präsenz des Unternehmens im Bereich der traditionellen und dekorativen Keramik wird durch Produkte mit feinen Oberflächen bestätigt.

FR L'entreprise renforce sa présence dans le secteur de la céramique traditionnelle et décorative, avec des produits de prestige.

'80

In costante evoluzione, nasce l'idea di associare la luce alla ceramica e vengono create le prime lampade da comodino.

EN In constant evolution, thanks to the idea of associating light with ceramics the company produces the first bedside lamps.

DE In ständiger Entwicklung wird die Idee geboren, Licht mit Keramik zu verbinden und es entstehen die ersten Nachttischlampen.

FR En perpétuelle évolution, l'entreprise a l'idée d'associer la lumière à la céramique et les premières lampes de chevet seront créées.

1985

Lo spirito innovativo porta al traguardo della progettazione della prima applique da parete, tutt'oggi a catalogo.

EN The innovative spirit leads to the design of the first wall lamp, still in the catalogue.

DE Der Innovationsgeist führt zum Ziel, die erste Wandleuchte zu entwickeln, die noch heute im Katalog zu finden ist.

FR L'esprit innovant pousse l'entreprise à la conception de la première applique murale, qui figure toujours dans son catalogue.

2001

La storica azienda diviene Belfiore SRL, cambiando proprietà e rinnovando la passione. Si iniziano ad usare i primissimi LED, innovazione fondamentale per il futuro dei prodotti.

EN The historic company becomes Belfiore SRL, changing ownership and renewing its passion. We begin to use the very first LEDs, a crucial innovation for the future of our products.

DE Das historische Unternehmen wird zu Belfiore SRL, wechselt den Eigentümer und erneuert die Leidenschaft. Man beginnt, die allerersten LED einzusetzen, eine grundlegende Innovation für die Zukunft der Produkte.

FR L'historique entreprise devient Belfiore S.r.l., en changeant de propriétaire avec une passion renouvelée. Les toutes premières LED commencent à être utilisées, une innovation fondamentale pour le devenir des produits.

2007

Dalla mente del titolare, dalle mani dei modellatori e dalle tecnologie del reparto illumino-tecnico nascono i primi prodotti da incasso, una novità nel mondo dell'illuminazione.

EN The introduction of the first recessed lighting collection is an innovation in the lighting market, result of the owner's creativity, the skilful hands of the model makers and the new technologies introduced by the lighting department.

DE Aus dem Geist des Inhabers, den Händen der Modellierer und der Technologie der lichttechnischen Abteilung werden die ersten Einbauprodukte geboren, eine Neuheit in der Welt der Beleuchtung.

FR L'esprit inventif de la direction, les mains des façonneurs et les technologies de l'atelier éclairage donnent naissance aux premiers produits encastrables, une nouveauté dans l'univers de l'éclairage.

2011

Si reinventa il potenziale creativo centrando in pieno le nuove richieste del mercato, viene studiato il CRISTALY®, si presenta la collezione completa da incasso e nasce il brand 9010.

EN The creative potential is reinvented by fully meeting the new market demands, from the study of CRISTALY®, to the introduction of the complete recessed collection and the presentation of the 9010 brand.

DE Das kreative Potential wird neu erfunden, indem es die neuen Marktanforderungen voll trifft, CRISTALY® wird untersucht, die neue Einbaukollektion vorgestellt und die Marke 9010 geboren.

FR Le potentiel créatif est réinventé en se concentrant entièrement sur les nouvelles demandes du marché, l'entreprise étudie le CRISTALY®, la collection complète d'appareils encastrables est présentée, et la marque 9010 voit le jour.

2018

La radicata esperienza porta i prodotti ad un livello di design ed innovazione di anno in anno sempre migliore. Festeggiamo i nostri primi 50 anni.

EN The deep-rooted experience brings the products to a level of design and innovation that is getting better and better every year. We celebrate our first 50 years.

DE Die tief verwurzelte Erfahrung bringt die Produkte von Jahr zu Jahr auf ein immer besseres Niveau an Design und Innovation. Wir feiern unsere ersten 50 Jahre.

FR La longue expérience de l'entreprise positionne les produits à un niveau de design et d'innovation qui augmente d'une année à l'autre. Nous fêtons notre premier cinquantenaire.

2020

Per soddisfare qualsiasi esigenza di illuminazione, viene ideata la nuova linea di illuminazione da esterno. Con impegno e dedizione il team 9010 crea BETALY®, un composto naturale dalla lavorazione artigianale, in grado di rendere ogni pezzo unico.

EN A new outdoor collection is designed to complete 9010 range. With a passion for lighting and a dedication to inspire, 9010 team creates BETALY®, a natural compound expression of skilled and meticulous craftsmanship, that makes this new collection unique.

DE Um allen Beleuchtungsbedürfnissen gerecht zu werden, wird die neue Beleuchtungsreihe für den Außenbereich entwickelt. Mit Engagement und Hingabe entwickelt das Team 9010 BETALY®, eine handwerklich verarbeitete natürliche Verbindung, die jedes Werk einzigartig macht.

FR Afin de répondre à toute exigence d'éclairage, la nouvelle ligne d'éclairage d'extérieur a été créée. Avec acharnement et dévouement, l'équipe 9010 crée BETALY®, un composé naturel travaillé artisanalement, qui fait de chaque produit une pièce unique.

Future

Questi sono i risultati di una storia d'ispirazione e d'impegno: 9010 è oggi un punto di riferimento nel mercato nazionale e mondiale, con la qualità dei prodotti Made in Italy, la passione di sempre e l'obiettivo di continuare ad evolversi.

EN These are the results of a history of inspiration and commitment: 9010 is today a benchmark in the national and world markets, thanks to the quality of Made in Italy products, the same passion as always, and the constant will to evolve.

DE Dies sind die Ergebnisse einer Geschichte von Inspiration und Engagement: 9010 ist heute ein Bezugspunkt auf dem nationalen und internationalen Markt, mit der Qualität der Produkte Made in Italy, der gewohnten Leidenschaft und dem Ziel, sich weiterzuentwickeln.

FR Ces résultats sont ceux d'une histoire d'inspiration et d'efforts: 9010 est aujourd'hui une référence sur le marché national et mondial, avec la qualité des produits Made in Italy, la passion de toujours et l'objectif de continuer à évoluer.



BETALY[®] 9010

9010 porta con sé la **ricchezza** di un passato artigianale e ne fa un contenitore per qualcosa di assolutamente **nuovo**: un materiale altamente performante adatto ad **ambienti esterni**.

EN 9010 takes the richness of an artisan past and turns it into a vessel for something completely new: a high-performance material suitable for outdoor spaces.

DE 9010 bringt den Reichtum einer handwerklichen Vergangenheit mit sich und macht daraus ein Gefäß für etwas vollkommen Neues: ein leistungsstarkes Material, das für den Außenbereich geeignet ist.

FR 9010, c'est la richesse d'un passé artisanal qui devient un support pour une absolue nouveauté: un matériau à hautes performances adapté aux environnements extérieurs.



Proudly handmade

Dalla natura proviene una materia prima dalla concretezza tangibile e adatta a qualsiasi tipo di ambiente esterno. In esso coesistono forza del materiale e leggerezza delle forme, versatilità e design di carattere. Il BETALY[®] di 9010 è un composto che rende ogni pezzo unico, grazie alla lavorazione artigianale che ci contraddistingue. La superficie di ogni pezzo sarà e deve essere irripetibile, poiché è nella sua eccezionale peculiarità che risiede la sua superiorità.

Un materiale nuovo ed importante, dalla verve artigianale, che personalizza subito l'ambiente e che permette al fruitore di godere della sinuosità tipica delle figure ideate dai designer 9010.

EN Nature gives us a raw material that's tangibly practical and can be used for any type of outdoor space. It combines material strength and lightness of form, versatility and characterful design. BETALY[®] by 9010 is a compound that makes every item unique, thanks to its distinctive artisan finish. The surface of every item is and must be unrepeatable, because its superior quality lies in its exceptional singularity.

This is an important new material with an artisan boldness which immediately customises a space and allows the user to enjoy the distinctive sinuousness of shapes conceived by the 9010 designers.

DE Aus der Natur stammt ein Rohstoff mit greifbarer Substanz, der für jeden Außenbereich geeignet ist. In ihm koexistieren Stärke des Materials und Leichtigkeit der Formen, Vielseitigkeit und Design mit Charakter. BETALY[®] von 9010 ist eine Verbindung, die dank der handwerklichen Verarbeitung, die uns auszeichnet, jedes Stück einzigartig macht. Die Oberfläche jedes Stücks wird und muss ohnegleichen sein, da seine Überlegenheit in seiner außergewöhnlichen Besonderheit liegt.

Ein neues und wichtiges Material mit handwerklichem Schwung, das der Umgebung sofort eine persönliche Note gibt und es dem Benutzer ermöglicht, die typischen Kurven der Figuren zu genießen, die von den Designern 9010 kreiert wurden.

FR La nature fournit une matière première vraiment tangible, adaptée à tout type d'environnement extérieur. La force du matériau côtoie la légèreté des formes, l'universalité se double d'un design de caractère. Le BETALY[®] de 9010 est un composé qui rend chaque pièce unique, grâce au travail artisanal qui nous distingue. La surface de chaque pièce sera et doit être inimitable, car c'est dans son exceptionnelle particularité que réside sa supériorité. Un matériau nouveau et important, à la verve artisanale, qui donne immédiatement du caractère au lieu et qui permet d'apprécier les rondeurs typiques des formes imaginées par les designers 9010.

BETALY®

Creations

I prodotti creati con BETALY® hanno un'eccellente resistenza all'usura, con un'altissima resistenza alla compressione e agli agenti atmosferici. Sono inoltre impermeabili ed adatti ad essere applicati in zone esterne, grazie alla parte elettrica con grado di protezione IP65.

BETALY® ha una superficie grezza e concreta che ricorda la natura, così come le sue forme essenziali e primitive, è un elemento in grado di adattarsi agli spazi esterni dando un accento di design d'impatto.

EN Products created using BETALY® have excellent resistance to wear and extremely high levels of resistance to compression and atmospheric agents. They are also waterproof and suitable for use in outdoor areas, thanks to IP65 protection for electrical components. BETALY® has a rough, textured surface which evokes nature and its primitive, essential shapes; a material that can adapt to exteriors and add an impactful designer touch.

DE Die mit BETALY® hergestellten Produkte weisen eine ausgezeichnete Verschleißfestigkeit mit höchster Beständigkeit gegen Druck- und Witterungseinflüsse auf. Darüber hinaus sind sie wasserdicht und dank dem elektrischen Teil mit Schutzgrad IP65 für die Verwendung in Außenbereichen geeignet. BETALY® hat eine rohe und konkrete Oberfläche, die an die Natur erinnert, so wie seine essentiellen und primitiven Formen. Es ist ein Element, das sich den Außenräumen anpassen kann und einen wirkungsvollen Designakzent schafft.

FR Les produits créés avec BETALY® sont extraordinairement résistants à l'usure, avec une très haute résistance à la compression et aux agents atmosphériques. Ils sont de plus imperméables et peuvent être installés à l'extérieur grâce à leur partie électrique à indice de protection IP65. BETALY® présente une surface brute et concrète qui rappelle la nature, tout comme ses formes essentielles et primitives, il s'agit d'un élément qui sait s'adapter aux espaces extérieurs en apportant une touche de design du plus grand effet.



La relazione tra la poesia della luce e la solidità del cemento crea i prodotti luminosi 9010, certi di emozionare.

Ogni prodotto viene realizzato con cura nella nostra sede storica di Nove (VI) ed ogni dettaglio di superficie o di colore ne testimonia l'unicità e la speciale manifattura artigianale.

EN 9010 lighting products are the result of the relationship between the poetry of light and the solidity of cement, and they're sure to impress. Every product is carefully made at our historic premises in Nove (VI), and every detail of surface or colour testifies to their uniqueness and meticulous artisan production.

DE Die Verbindung zwischen der Poesie des Lichts und der Festigkeit des Zements kreiert die Beleuchtungen 9010, die mit Sicherheit begeistern.

Jedes Produkt wird in unserem historischen Werk in Nove (VI) mit Sorgfalt hergestellt und jedes Detail der Oberfläche oder der Farbe zeugt von der Einzigartigkeit und der speziellen Handwerkskunst.

FR Le lien entre la poésie de la lumière et la robustesse du béton crée engendre les produits d'éclairage 9010.

Chaque produit est réalisé minutieusement à notre siège historique de Nove (province de Vicence) et chaque détail de surface ou de couleur atteste de l'unicité et de la particulière fabrication artisanale.



Caratteristiche BETALY®



Adatto per ambienti esterni / Suitable for outdoor use
Geeignet für Outdoor / Adapté pour l'extérieur



Resistente al gelo / Frost resistant
Frostbeständig / Résistant au gel



Resistenza termica / Thermal resistant
Thermische Beständigkeit / Résistance thermique



Atossico / Non-toxic
Nicht toxisch / Non toxiques



Assenza di deformazione / Non deforming
Keine Deformation / Absence de déformation



Assenza di reazioni chimiche / Absence of chemical reaction
Ohne chemische Reaktion / Absence de réactions chimiques



Non infiammabile / Non flammable
Nicht entflammbar / Non inflammable



Alta resistenza agli urti / High Impact resistance
Hohe Schlagbeständigkeit / Haute résistance aux chocs



Tocco materico / Matric touch
Materialeffekt / Touche Matière



Resistenza ai raggi UV / UV resistant
UV-Beständigkeit / Résistant aux rayons UV



Resistenza alla salinità / Salt corrosion resistant
Salzkorrosionsbeständig / Résistant aux agressions salines



Resistente all'abrasione / Abrasion resistant
Abriebbeständig / Résistant à l'abrasion



We are light designers

Una collezione innovativa caratterizzata da design e alta qualità, grande attenzione alle tendenze e cura dei dettagli. Un metodo produttivo che garantisce resistenza e solidità ma pur sempre artigianale, permettendo di realizzare prodotti irripetibili ed unici. Una soluzione ideale per terrazze, vialetti, giardini, ed ogni ambiente esterno da illuminare.

EN An innovative collection characterised by design and excellent quality; a close focus on current trends and attention to detail. Our production methods guarantee resistance and robustness while retaining artisan quality, allowing us to create items that are unique and unrepeatable. The perfect solution for terraces, walkways, gardens and any outside space that needs lighting.

DE Eine durch Design und hoher Qualität gekennzeichnete innovative Kollektion mit großem Augenmerk auf Trends und Liebe zum Detail. Eine Produktionsmethode, die Beständigkeit und Solidität gewährleistet, aber dennoch handwerklich ist, und einmalige und einzigartige Produkte schafft. Eine ideale Lösung für Terrassen, Wege, Gärten und alle Außenbereiche, die zu beleuchten sind.

FR Une collection innovante dont les caractéristiques sont le design et la haute qualité, une grande attention aux tendances et le soin du détail. Une méthode de fabrication qui garantit résistance et solidité mais qui reste artisanale, permettant de réaliser des produits inimitables et uniques. Une solution idéale pour les terrasses, allées, jardins et tout espace extérieur à éclairer.

Paolo D'Arrigo
 > COBRA, DOUBLE, MONO, SER 18

Formidable Design
 > ERCOLE 44

Kalin Gemignani
 > ZETA 54

Alberto Ghirardello
 > BEAN, DOMINO, MINU' 64

HENRY & CO.
 > LEVICO 86

Grazie alle riuscite collaborazioni con spiccate personalità creative del design, 9010 ha confezionato una serie di prodotti capaci di illuminare e di stupire.

Illuminare dalla nostra mente con tradizione, con mezzo secolo di storia di un'azienda che ha fatto del Made in Italy il suo marchio di fabbrica.

Stupire dal nostro cuore con passione, quella che non ci manca mai, con forme e creazioni di luce che compongono la nostra filosofia.

EN Thanks to our successful collaborations with renowned design creatives, 9010 has developed a series of products that illuminate and astonish. Illuminate with our creativity and our tradition, a half-century history of a firm where Made in Italy has become a trademark. Astonish with our heart and our passion, ever-present in shapes and lighting creations that build our philosophy.

DE Dank der erfolgreichen Zusammenarbeit mit unverkennbaren kreativen Persönlichkeiten des Designs hat 9010 eine Reihe von Produkten entwickelt, die beleuchten und in Erstaunen versetzen können. Unseren Geist mit Tradition erleuchten, mit einem halben Jahrhundert Unternehmensgeschichte, die das Made in Italy zu seinem Markenzeichen gemacht hat.

Aus unserem Herzen mit Leidenschaft erstaunen, die uns nie fehlt, mit Formen und Lichtkreationen, die unsere Philosophie ausmachen.

FR Grâce à d'heureuses collaborations avec d'émérites personnalités créatives du design, 9010 a réalisé une série de produits d'éclairage stupéfiants. Éclairer par notre créativité avec tradition, une histoire d'un demi-siècle d'une entreprise qui a fait du Made in Italy sa marque de fabrique. Stupéfier par notre cœur avec passion, toujours au rendez-vous, avec des formes et des créations de lumière qui font notre philosophie.

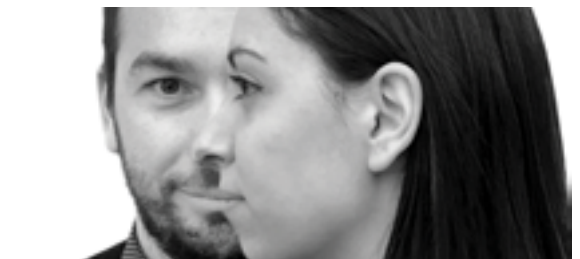

Paolo D'Arrigo

Paolo D'Arrigo è un designer che vive il progetto come un'alchimia di natura e hi-tech dove la forma è l'esito di un processo che si misura con i vincoli della materia e li spinge oltre. Attivo nell'associazionismo, ha presieduto la delegazione ADI Lazio e l'associazione In Forma Azione. Insegna Design industriale agli allievi de La Sapienza di Roma. Ha ottenuto numerosi riconoscimenti e premi in Italia e all'estero, tra i quali il German Design Awards e tre ADI Design Index.

EN Paolo D'Arrigo is a designer who approaches his projects as an alchemy of nature and hi-tech, in which shape is the result of a process that challenges the limits of material and goes beyond them. An active member of several associations, he has chaired the ADI Lazio delegation and the In Forma Azione association. He teaches Industrial Design to students at La Sapienza University in Rome. He is the recipient of numerous awards in Italy and abroad, including the German Design Award and three times the ADI Design Index.

DE Paolo D'Arrigo ist ein Designer, der das Projekt als eine Alchemie aus Natur und Hi-Tech lebt, in der die Form das Ergebnis eines Vorgangs ist, der an den Einschränkungen der Materie gemessen wird und sie weiterrückt. In Verbänden aktiv, leitete er die Delegation ADI Lazio und den Verband In Forma Azione. Er unterrichtet Industriedesign an der Universität La Sapienza in Rom. Er hat zahlreiche Auszeichnungen und Preise in Italien und im Ausland erhalten, darunter der German Design Award und drei ADI Design Index.

FR Paolo D'Arrigo est un designer qui vit le projet à la manière d'une alchimie de nature et de haute technologie, où la forme est le dénouement d'un processus qui se mesure aux contraintes de la matière et les pousse au-delà. Actif dans le milieu des associations, il a été Président de la délégation ADI Latium et de l'association In Forma Azione. Il enseigne le Design industriel aux étudiants de La Sapienza, à Rome. Il a obtenu de nombreux prix et récompenses en Italie et dans le monde, dont le German Design Awards et trois ADI Design Index.

Paolo D'Arrigo





La collaborazione con 9010 mi ha subito appassionato per la natura materica e le potenzialità formali dei materiali ceramici utilizzati per la produzione. Volendo sviluppare la proposta di illuminazione per esterni ci siamo concentrati su diversi approcci progettuali, dall'innovazione tipologica e funzionale a quella formale. Ispirandoci alle cose della natura, musa del nostro percorso progettuale, sono nate tre proposte eterogenee fra loro, archetipiche e riconoscibili, per soddisfare un ampio ventaglio di necessità dell'illuminazione outdoor e suggerire soluzioni alternative.

EN I was immediately enthusiastic about collaborating with 9010, because of the concrete nature and the formal potential of the ceramic materials used in their products. Seeking to develop solutions for outdoor lighting, we focused on different design approaches, ranging from innovation in style and function to formal design elements. Taking inspiration from the natural world, which acted as our muse, we came up with three very different proposals, archetypal and recognisable, which could meet a wide range of outdoor lighting needs and also suggest alternative solutions.

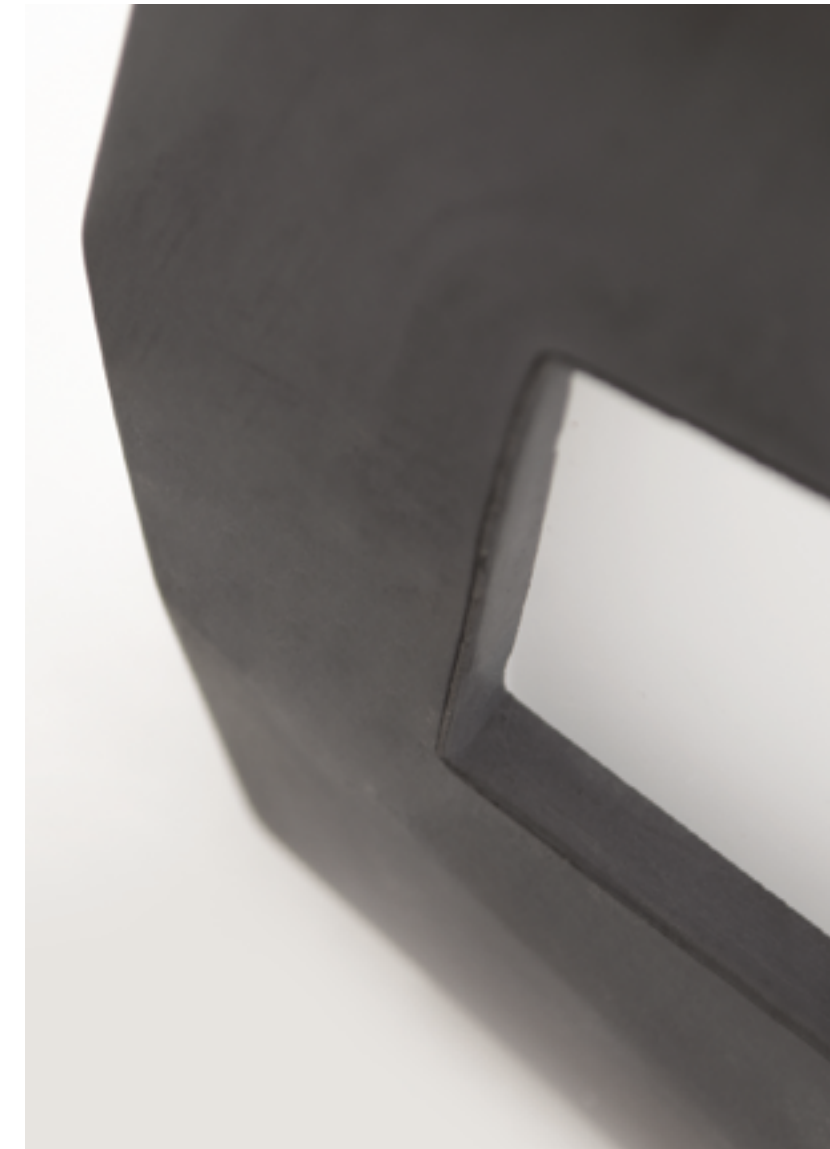

DE Die Zusammenarbeit mit 9010 hat mich sofort wegen der materiellen Natur und den formalen Möglichkeiten der Keramikmaterialien begeistert, die für die Produktion verwendet werden. Bei der Entwicklung des Vorschlags für die Außenbeleuchtung haben wir uns auf verschiedene Designansätze konzentriert, von der typologischen und funktionellen bis hin zur formalen Innovation. Inspiriert von der Natur, Muse unseres Projekts, sind drei untereinander heterogene Vorschläge entstanden, die archetypisch und wiedererkennbar sind, um eine breite Palette von Beleuchtungsbedürfnissen im Freien zu befriedigen und alternative Lösungen vorzuschlagen.

FR La collaboration avec 9010 m'a immédiatement passionné pour la nature de la matière et les potentiels de forme des matériaux céramiques utilisés pour la production. Désirant développer l'offre d'éclairage d'extérieur, nous sommes penchés sur différentes méthodes de conception, de l'innovation typologique et fonctionnelle, à la formelle. En nous inspirant des choses de la nature, muse de notre parcours de conception, trois propositions hétéroclites ont pris forme, archétypiques et identifiables, pour répondre à une grande variété d'exigences de l'éclairage extérieur et suggérer des solutions alternatives.

COBRA



"Non vogliamo imitare le cose della natura, ma piuttosto studiarne i principi di cui essa si serve".

Buckminster Fuller

Una linea che si estende dal terreno, attraversata dalla sfumatura della luce, si curva in maniera fluida, e diventa forma iconica. Questa è l'essenza di Cobra, un oggetto zoomorfo, che si ispira nelle forme ai principi della natura.

EN "We don't seek to imitate natural things, but rather explore the principles they use". Buckminster Fuller. A line that extends upwards from the ground and passes through the shading of light, then fluidly curves and becomes an iconic form. This is the essence of Cobra, a zoomorphic object whose shape is inspired by natural principles.

DE "Wir wollen nicht die Natur imitieren, sondern vielmehr die Prinzipien erforschen, deren sie sich bedient". Buckminster Fuller. Eine Linie, die sich vom Boden aus erstreckt, von den Schattierungen des Lichts durchbrochen wird, sich fließend krümmt und zu einer ikonischen Form wird. Das ist die Essenz von Cobra, einem zoomorphen Objekt, das sich in den Formen an den Prinzipien der Natur inspiriert.

FR "Notre intention n'est pas d'imiter les choses de la nature, mais plutôt d'en étudier les principes dont elle se sert". Buckminster Fuller. Une ligne qui s'étend à partir du sol, traversée par la nuance de la lumière elle se courbe en douceur, et devient forme iconique. Telle est l'essence de Cobra, un objet zoomorphe, inspiré dans les formes des principes de la nature.



Paletti / Bollard / Pollerleuchten / Bornes



BETALY®
9010

made in Italy

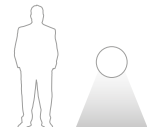

Codice articolo* / Article Code*	1107-396-30159
Grado di protezione / Protection degree / Schutzart / Degré de protection	IP65
Classe di isolamento / Insulation Class / Schutzklasse / Classe d'isolation	I
Potenza / Power / Leistung / Puissance	LED 10W
Tensione / Tension / Spannung / Tension	220-240V
Tonalità / Colour temperature / Farbtemperatur / Température de couleur	3000°K
Lumen	800lm
CRI	80
Colori dei materiali* / Colors of the materials* / Farben der Materialien* / Couleurs des matériaux*	



Alimentatore incluso / Power Supply included / Inklusive Betriebsgerät / Alimentation incluse

A: Vetro temperato acidato / Tempered etched glass / Geätztes gehärtetes Glas / Verre trempé satiné

Colori dei materiali / Colors of the materials
Farben der Materialien / Couleurs des matériaux



392
Bianco / White
Weiss / Blanc



393
Verde / Green
Grün / Vert



394
Corten



395
Grigio / Grey
Grau / Gris



396
Nero / Black
Schwarz / Noir

IT Misure espresse in mm, tolleranza +/- 1-2 mm. L'azienda si riserva la facoltà di apportare variazioni di dati caratteristici, materiali, design, stili, tonalità, senza alcun preavviso.

EN Measures in mm, tolerance +/- 1/2 mm. The company reserves the right to carry out variations to technical details, materials, design, style, colors with no previous notice.

DE Die Masse sind in mm, mit einer Tolleranz von +/- 1-2 mm ausgedrückt, Die Firma behält sich das Recht vor ohne Voranmeldung Änderungen an den Werkstoffen, am Design, am Stil und an der Färbung vorzunehmen.

FR Mesures en mm, tolérance +/- 1/2 mm. La société se réserve le droit de modifier sans préavis les détails techniques, les matériaux, le design, le style et les couleurs.

1107-392-30159



MONO E DOUBLE



"Ci sono due modi di diffondere luce; essere la candela o lo specchio che riflette". *Edith Wharton*
Illuminazione binomiale, per rispondere a molteplici esigenze, Mono & Double sono due strutture di luce dal design rigoroso. Un connubio di eleganza e funzionalità.

Paolo Piretti

EN "There are two ways of spreading light: to be the candle or the mirror that reflects it". *Edith Wharton*. Binomial illumination to meet a multitude of needs, Mono & Double are two lighting structures of bold and rigorous design. A fusion of elegance and functionality.

DE "Es gibt zwei Möglichkeiten, Licht zu verbreiten; die Kerze oder der reflektierende Spiegel". *Edith Wharton*. Binomiale Beleuchtung, um zahlreichen Anforderungen gerecht zu werden, sind Mono & Double zwei Lichtstrukturen mit strengem Design. Eine Kombination aus Eleganz und Funktionalität.

FR "Il existe deux façons de diffuser la lumière ; être la bougie ou le miroir qui réfléchit". *Edith Wharton*. Éclairage binomial, pour répondre à de multiples exigences, Mono & Double sont deux structures lumineuses au design rigoureux. Une combinaison d'élégance et de fonctionnalité.





BETALY®
9010

made in Italy

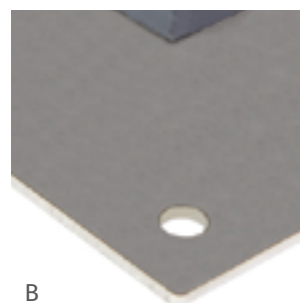
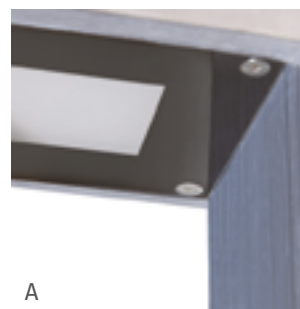
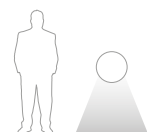

D

- A: Vetro temperato acidato / Tempered etched glass / Geätztes gehärtetes Glas / Verre trempé
 B: Base in acciaio / Steel Base / Fuß aus Stahl / Base en acier
 C: Riflettore in acciaio satinato / Satin Steel Reflector / Reflektor aus satiniertem Stahl / Réflecteur en acier satiné
 D: Copri base in BETALY® (p. 148) / Cover-base in BETALY® (p. 148) / Sockel aus BETALY® (p. 148) / Couverture de la base en BETALY® (p. 148)

Codice articolo* / Article Code* **1103B-396-3012**
 Grado di protezione / Protection degree **IP65**
 Schutzart / Degré de protection
 Classe di isolamento / Insulation Class **I**
 Schutzklasse / Classe d'isolation
 Potenza / Power **LED 10W**
 Leistung / Puissance
 Tensione / Tension **170-265V**
 Spannung / Tension
 Tonalità / Colour temperature **3000°K**
 Farbtemperatur / Température de couleur
 Lumen **800lm**
 CRI **80**

Colori dei materiali* / Colors of the materials*
 Farben der Materialien* / Couleurs des matériaux*
 392 393 394 395 396

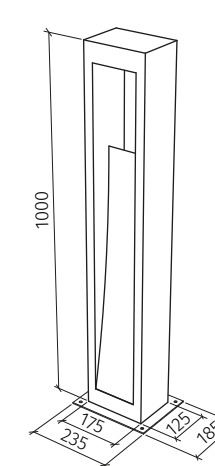

24,5 Kg



Alimentatore incluso / Power Supply included / Inklusive Betriebsgerät / Alimentation incluse

Colori dei materiali / Colors of the materials
 Farben der Materialien / Couleurs des matériaux



392
 Bianco / White
 Weiss / Blanc



393
 Verde / Green
 Grün / Vert



394
 Corten



395
 Grigio / Grey
 Grau / Gris



396
 Nero / Black
 Schwarz / Noir

IT Misure espresse in mm, tolleranza +/- 1-2 mm. L'azienda si riserva la facoltà di apportare variazioni di dati caratteristici, materiali, design, stili, tonalità, senza alcun preavviso.

EN Measures in mm, tolerance +/- 1/2 mm. The company reserves the right to carry out variations to technical details, materials, design, style, colors with no previous notice.

DE Die Masse sind in mm, mit einer Tolleranz von +/- 1-2 mm ausgedrückt, Die Firma behält sich das Recht vor ohne Voranmeldung Änderungen an den Werkstoffen, am Design, am Stil und an der Färbung vorzunehmen.

FR Mesures en mm, tolérance +/- 1/2 mm. La société se réserve le droit de modifier sans préavis les détails techniques, les matériaux, le design, le style et les couleurs.

1103B-394-3012



1103B-394-3012



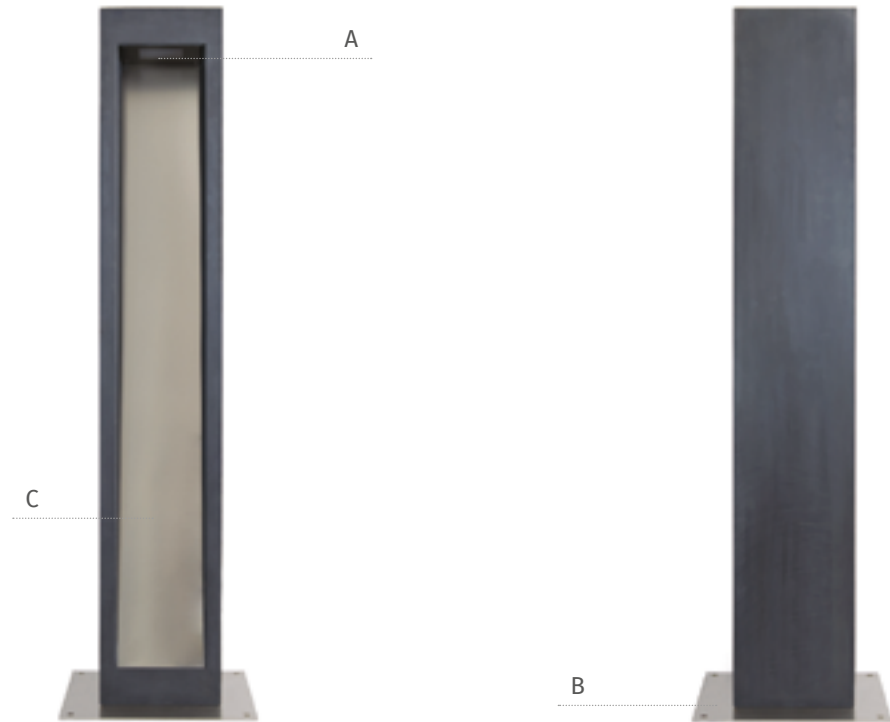
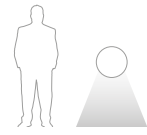

Codice articolo* / Article Code* **1103A-396-3012**

Grado di protezione / Protection degree **IP65**
Schutzart / Degré de protection

Classe di isolamento / Insulation Class **I**
Schutzklasse / Classe d'isolation

Potenza / Power **LED 10W**
Leistung / Puissance

Tensione / Tension **170-265V**
Spannung / Tension

Tonalità / Colour temperature **3000°K**
Farbtemperatur / Température de couleur

Lumen **800lm**

CRI **80**

Colori dei materiali* / Colors of the materials*
Farben der Materialien* / Couleurs des matériaux*
392 393 394 395 396

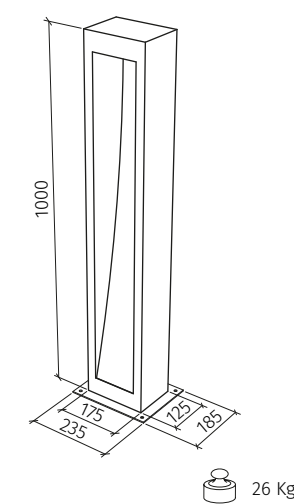

Alimentatore incluso / Power Supply included / Inklusive Betriebsgerät / Alimentation incluse

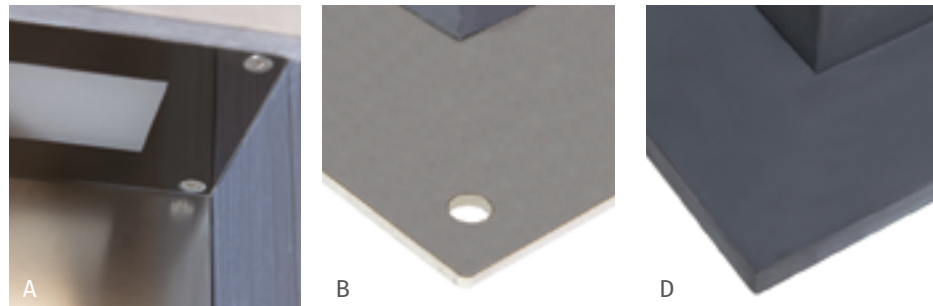

A: Vetro temperato acidato / Tempered etched glass / Geätztes gehärtetes Glas / Verre trempé

B: Base in acciaio / Steel Base / Fuß aus Stahl / Base en acier

C: Riflettore in acciaio satinato / Satin Steel Reflector / Reflektor aus satiniertem Stahl / Réflecteur en acier satiné

D: Copri base in BETALY® (p. 148) / Cover-base in BETALY® (p. 148) / Sockel aus BETALY® (p. 148) / Couverture de la base en BETALY® (p. 148)

Colori dei materiali / Colors of the materials
Farben der Materialien / Couleurs des matériaux



392
Bianco / White
Weiss / Blanc

393
Verde / Green
Grün / Vert

394
Corten

395
Grigio / Grey
Grau / Gris

396
Nero / Black
Schwarz / Noir

IT Misure espresse in mm, tolleranza +/- 1-2 mm. L'azienda si riserva la facoltà di apportare variazioni di dati caratteristici, materiali, design, stili, tonalità, senza alcun preavviso.

EN Measures in mm, tolerance +/- 1/2 mm. The company reserves the right to carry out variations to technical details, materials, design, style, colors with no previous notice.

DE Die Masse sind in mm, mit einer Tolleranz von +/- 1-2 mm ausgedrückt, Die Firma behält sich das Recht vor ohne Voranmeldung Änderungen an den Werkstoffen, am Design, am Stil und an der Färbung vorzunehmen.

FR Mesures en mm, tolérance +/- 1/2 mm. La société se réserve le droit de modifier sans préavis les détails techniques, les matériaux, le design, le style et les couleurs.

1103A-396-3012



SER



“La biomimesi è innovazione ispirata dalla natura”. *Janine M. Benyus*

Ser è un prodotto archetipico, un ibrido che coniuga i principi di tecnologia e natura. Un prodotto flessibile e dinamico nell'uso, dotato di un'estetica essenziale e mimetica.

Paolo Piretti

EN “Biomimicry is innovation inspired by nature”. *Janine M. Benyus*
Ser is an archetypal product, a hybrid that combines the principles of technology and nature. A product that's flexible and dynamic in use, with a minimalist, mimetic aesthetic.

DE “Die Biomimetik ist eine von der Natur inspirierte Innovation”. *Janine M. Benyus*
Ser ist ein archetypisches Produkt, ein Hybrid, der die Prinzipien von Technologie und Natur kombiniert. Ein beim Gebrauch flexibles und dynamisches Produkt mit essentieller und mimetischer Ästhetik.

FR “Le biomimétisme est l'innovation inspirée de la nature”. *Janine M. Benyus*
Ser est un produit archétypique, un hybride qui associe les principes de technologie et de la nature. Un produit d'utilisation flexible et dynamique, avec une esthétique essentielle et mimétique.





BETALY®
9010

made in Italy

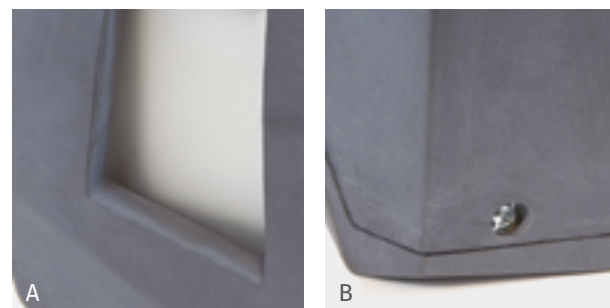
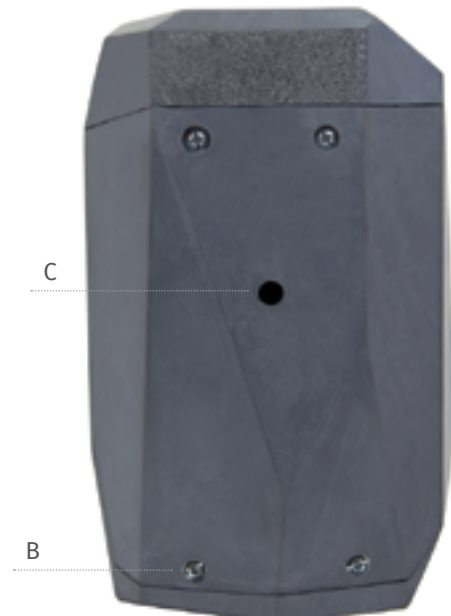

A: Vetro temperato acidato / Tempered etched glass / Geätztes gehärtetes Glas / Verre trempé

B: Coperchio di chiusura / Back Cover / Rückabdeckung / Couverture

C: Foro uscita cavo / Cable exit hole / Kabelausgang / Sortie du câble

Colori dei materiali / Colors of the materials
Farben der Materialien / Couleurs des matériaux



392
Bianco / White
Weiss / Blanc



393
Verde / Green
Grün / Vert



394
Corten



395
Grigio / Grey
Grau / Gris



396
Nero / Black
Schwarz / Noir

Codice articolo* / Article Code* **1102-396-3012**

Grado di protezione / Protection degree **IP65**
Schutzart / Degré de protection

Classe di isolamento / Insulation Class **I**
Schutzklasse / Classe d'isolation

Potenza / Power **LED 10W**
Leistung / Puissance

Tensione / Tension **170-265V**
Spannung / Tension

Tonalità / Colour temperature **3000°K**
Farbtemperatur / Température de couleur

Lumen **800lm**

CRI **80**

Colori dei materiali* / Colors of the materials*
Farben der Materialien* / Couleurs des matériaux*



Alimentatore incluso / Power Supply included / Inklusive Betriebsgerät / Alimentation incluse

Possibili posizioni / Possible positions
Mögliche Positionen / Positions possibles

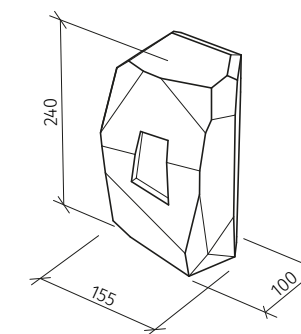
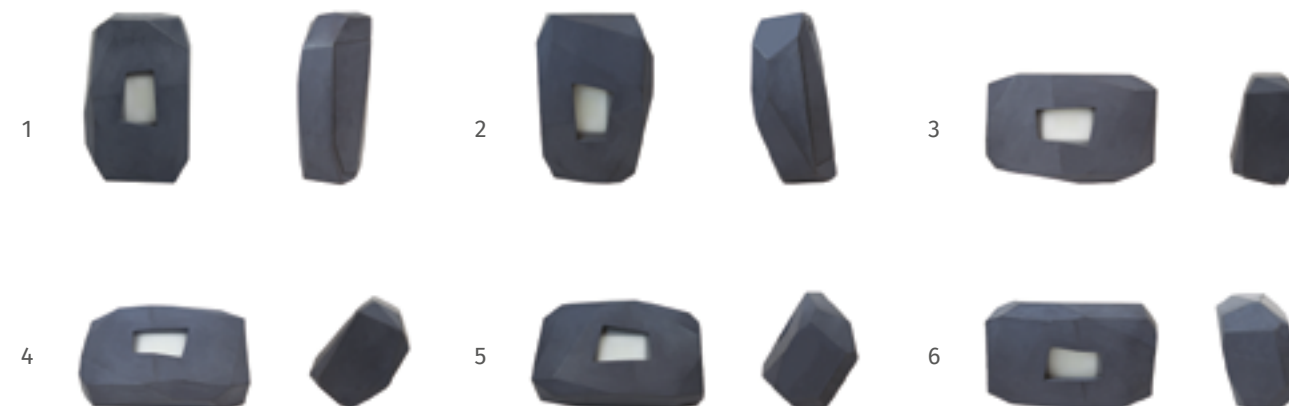

3,5 Kg

IT Misure espresse in mm, tolleranza +/- 1-2 mm. L'azienda si riserva la facoltà di apportare variazioni di dati caratteristici, materiali, design, stili, tonalità, senza alcun preavviso.

EN Measures in mm, tolerance +/- 1/2 mm. The company reserves the right to carry out variations to technical details, materials, design, style, colors with no previous notice.

DE Die Masse sind in mm, mit einer Tolleranz von +/- 1-2 mm ausgedrückt, Die Firma behält sich das Recht vor ohne Voranmeldung Änderungen an den Werkstoffen, am Design, am Stil und an der Färbung vorzunehmen.

FR Mesures en mm, tolérance +/- 1/2 mm. La société se réserve le droit de modifier sans préavis les détails techniques, les matériaux, le design, le style et les couleurs.

1102-396-3012



1102-395-3012



Formidable Studio

La collaborazione tra l'interior designer Giulia Ciccarese (1988) e l'architetto Devis Busato (1981), laureati presso lo IUAV di Venezia, nasce nel 2014. Creatività, ricerca e multidisciplinarietà sono il punto di partenza del loro percorso progettuale e professionale nel campo del design e della progettazione architettonica. Lo stesso anno danno vita al progetto Formidable, acronimo di forma, identità e potenzialità, ma anche, letteralmente, "meraviglioso" come il processo creativo che caratterizza la loro professione.

EN The collaboration between interior designer Giulia Ciccarese (born 1988) and architect Devis Busato (born 1981), who both studied at the IUAV in Venice, dates back to 2014. Creativity, research and multiple disciplines are the starting point for their professional journey in the fields of design and architecture. The same year they created the Formidable project - an acronym for form, identity and ability, but also literally 'marvellous', as the creative process that characterises their profession.

DE Die Zusammenarbeit zwischen der Innenarchitektin Giulia Ciccarese (1988) und dem Architekten Devis Busato (1981), der an der IUAV in Venedig studiert hat, wird 2014 geboren. Kreativität, Forschung und Multidisziplinarität sind die Ausgangspunkte ihrer Gestaltung und beruflichen Laufbahn im Bereich Design und Architekturdesign. Im selben Jahr entsteht das Projekt Formidable, ein Akronym für Form, Identität und Potenzial, aber auch wortwörtlich "wunderbar", wie der kreative Prozess, der ihren Beruf kennzeichnet.

FR La collaboration entre l'architecte d'intérieur Giulia Ciccarese (1988) et l'architecte Devis Busato (1981), diplômés à IUAV de Venise, date de 2014. Créativité, recherche et multidisciplinarité sont les points de départ de leur parcours de conception et professionnels dans le design et l'architecture. La même année, ils créent le projet Formidable, acronyme de forme, identité et potentialité, mais qui signifie aussi, littéralement, « merveilleux », comme le processus créatif qui caractérise leur métier.

Devis Busato



Giulia Ciccarese

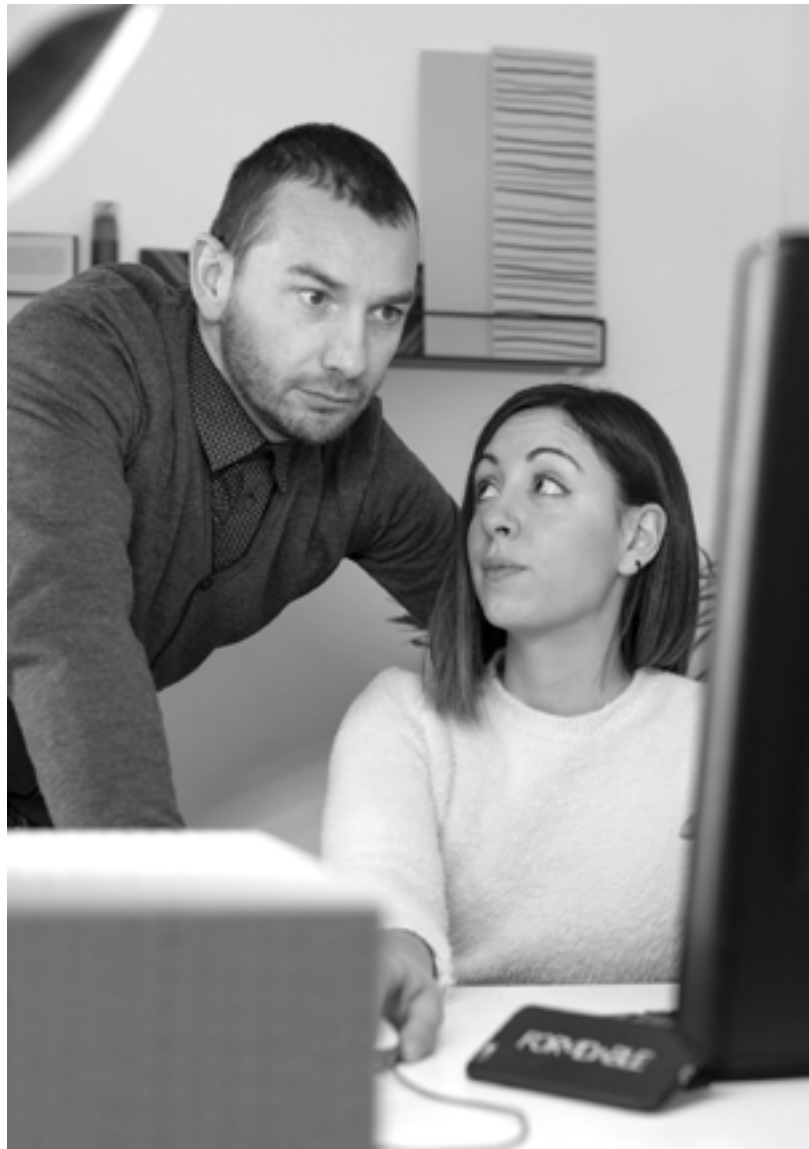

Forme semplici e scultoree definiscono con personalità la collezione di lampade per esterni Ercole. Le linee pulite ed essenziali sono un richiamo al tempio circolare delle vestali custodi del fuoco sacro. Così un cilindro in BETALY® ed una serie di colonnine sormontate da un disco in ALUMITE® proteggono e plasmano la fonte luminosa, rendendo Ercole un prodotto dalla forte valenza tecnica ed estetica.

EN Simple, sculptural forms give character to the Ercole collection of outdoor lamps. Clean, minimal lines are reminiscent of the circular temple of the Vestals, custodians of the holy fire. In the same way, a cylinder of BETALY® and a series of small columns topped by an ALUMITE® disc protect and shape the light source, making Ercole a highly technical and aesthetic item.



DE Einfache und skulpturähnliche Formen prägen die Persönlichkeit der Kollektion von Leuchten für den Außenbereich von Ercole. Die klaren und essentiellen Linien erinnern an den kreisförmigen Tempel der Vestalinnen, die das heilige Feuer hüteten. Ein Zylinder aus BETALY® und eine Reihe von Säulen, die von einer Scheibe aus ALUMITE® überragt werden, schützen und formen die Lichtquelle und machen Ercole zu einem Produkt mit starkem technischen und ästhetischen Wert.

FR Les formes simples et essentielles définissent avec caractère la collection de lampes d'extérieur Ercole. Les lignes nettes et essentielles rappellent le temple circulaire des vestales gardiennes du feu sacré. Ainsi, un cylindre en BETALY® et une série de colonnes surmontées d'un disque en ALUMITE® abritent et modèlent la source lumineuse, en faisant d'Ercole un produit à fort contenu technique et esthétique.

ERCOLE



Ercole, come un segno materico che coniuga funzionalità ed estetica, punto di incontro tra natura ed architettura, è caratterizzata da una luce indiretta ma al contempo decisa, ideale per spazi outdoor.

*Denis Fontato
Giulio Licavisi*

EN Like a physical sign that combines aesthetics and function, a meeting point of nature and architecture, Ercole is characterised by a light that's indirect yet at the same time confident, ideal for outdoor spaces.

DE Ercole, wie ein materielles Zeichen, das Funktionalität und Ästhetik kombiniert, ein Treffpunkt zwischen Natur und Architektur, wird durch indirektes, aber gleichzeitig starkes Licht gekennzeichnet, das sich ideal für Außenbereiche eignet.

FR Ercole, comme un signe de matière qui allie fonctionnalité et esthétique, point de rencontre entre nature et architecture, se caractérise par une lumière à la fois indirecte mais définie, idéale pour les espaces extérieurs.



Paletti / Bollard / Pollerleuchten / Bornes

CE ALUMITE® 9010 BETALY® 9010

made in Italy



Codice articolo* / Article Code* **1109-396-35**

Grado di protezione / Protection degree **IP65**
Schutzart / Degré de protection

Classe di isolamento / Insulation Class **II**
Schutzklasse / Classe d'isolation

Potenza / Power **MAX 10W (GU10 Ø50 **)**
Leistung / Puissance

Tensione / Tension **240V**
Spannung / Tension

Colori dei materiali* / Colors of the materials*
Farben der Materialien* / Couleurs des matériaux*

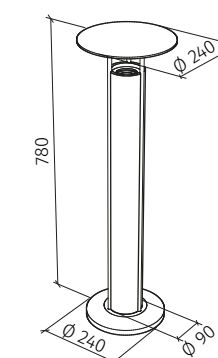
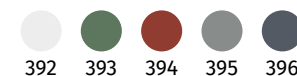

10 Kg



** Lampadina GU10 non fornita / GU10 bulb not included / GU10 Leuchtmittel nicht im Lieferumfang enthalten / Ampoule GU10 n'est pas fournie

A: Vetro temperato / Tempered glass / Gehärtetes Glas / Verre trempé

B: Struttura in ALUMITE verniciato ral 9010 opaco / Painted ral 9010 mat ALUMITE body lamp /
Leuchtenkörper aus matt-lackiertem ALUMITE ral 9010 / Corps de lampe en ALUMITE verni ral 9010 mat

C: Copri base in BETALY® incluso / Cover-base in BETALY® included / Inklusiv Sockel aus BETALY® / Couverture de la base en BETALY® incluse

Colori dei materiali / Colors of the materials
Farben der Materialien / Couleurs des matériaux



392
Bianco / White
Weiss / Blanc



393
Verde / Green
Grün / Vert



394
Corten



395
Grigio / Grey
Grau / Gris



396
Nero / Black
Schwarz / Noir

IT Misure espresse in mm, tolleranza +/- 1-2 mm. L'azienda si riserva la facoltà di apportare variazioni di dati caratteristici, materiali, design, stili, tonalità, senza alcun preavviso.

EN Measures in mm, tolerance +/- 1/2 mm. The company reserves the right to carry out variations to technical details, materials, design, style, colors with no previous notice.

DE Die Masse sind in mm, mit einer Tolleranz von +/- 1-2 mm ausgedrückt, Die Firma behält sich das Recht vor ohne Voranmeldung Änderungen an den Werkstoffen, am Design, am Stil und an der Färbung vorzunehmen.

FR Mesures en mm, tolérance +/- 1/2 mm. La société se réserve le droit de modifier sans préavis les détails techniques, les matériaux, le design, le style et les couleurs.

1109-396-35



1109-396-35



Kalin Gemignani

Architetto lucchese, nato in Bulgaria. Dopo alcuni anni di esperienza in un'azienda nel settore dell'illuminazione di design, nel 2018 apre il proprio studio di progettazione architettonica e del prodotto. Presente al Salone Satellite di Milano nel 2019 dove nasce la collaborazione con 9010.

EN Kalin Gemignani is a Lucca-based architect, born in Bulgaria. Following several years' experience in a designer lighting firm, in 2018 he opened his own architecture and product design studio. In 2019 he attended the Salone Satellite in Milan, where his collaboration with 9010 began.

DE Architekt aus Lucca, geboren in Bulgarien. Nach einigen Jahren Erfahrung in einem Unternehmen im Bereich der Designbeleuchtung hat er 2018 sein eigenes Studio für architektonisches Design und Produktdesign eröffnet. Während seiner Teilnahme am Salone Satellite in Mailand im Jahr 2019 wird die Zusammenarbeit mit 9010 geboren.

FR Architecte de Lucques, né en Bulgarie. Après quelques années d'expérience dans une entreprise du secteur de l'éclairage design, en 2018 il ouvre son propre cabinet d'architecture et de conception de produits. Il est présent au Salon Satellite de Milan en 2019 où s'instaure la collaboration avec 9010.

Kalin Gemignani



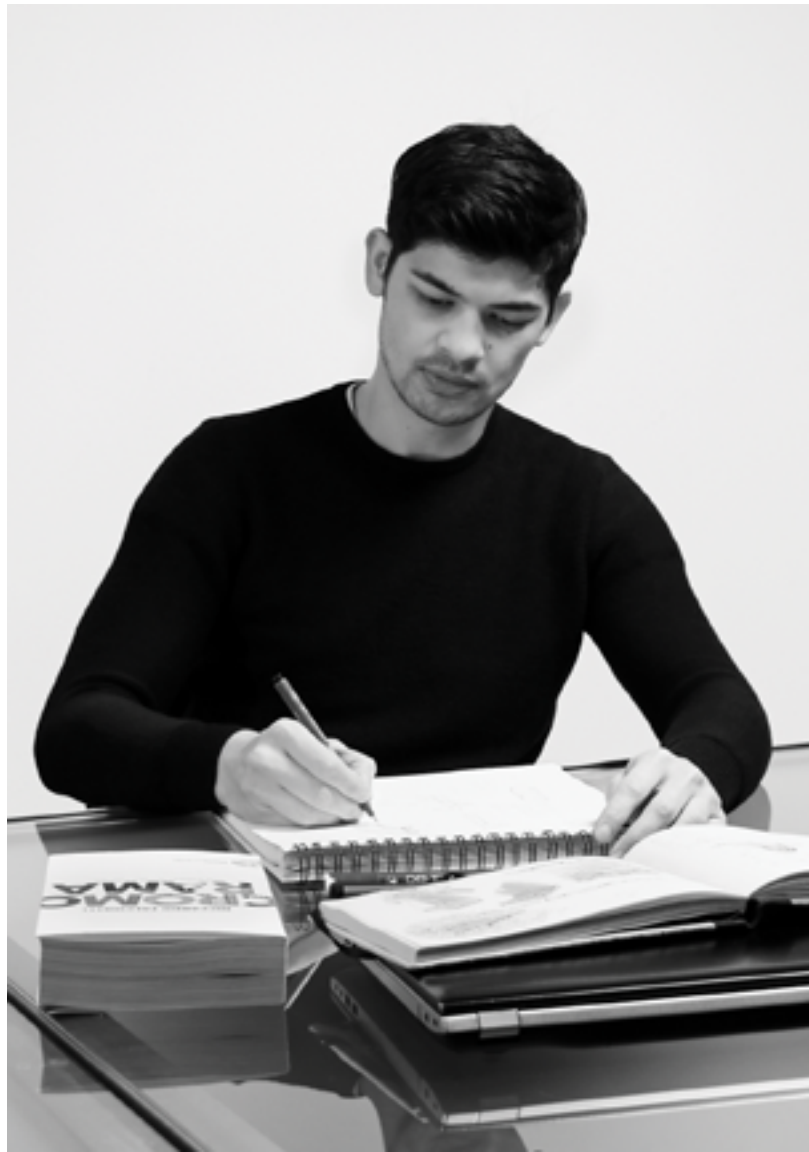

Il design di Kalin Gemignani è orientato ad un linguaggio sintetico, che interpreta stili di vita contemporanei: forma e funzione si definiscono reciprocamente; è la linearità del segno che le traduce in elementi concreti, proprio come è avvenuto per la lampada Zeta: progettata per essere realizzata in BETALY®, materiale opaco che resiste agli agenti atmosferici esterni e muta nel tempo integrandosi nel contesto in cui è inserito. La forma unica e slanciata, rende Zeta ideale per qualsiasi ambiente esterno.

EN Kalin Gemignani's design is based around a synthetic language which interprets contemporary lifestyles: form and function define each other; it's the linearity of the sign that transfers language into concrete shapes; and this is what happened with the Zeta lamp, designed to be made in BETALY®, an opaque material that can withstand the weather and change over time, integrating into its setting. The unique slender shape makes Zeta perfect for any outdoor space.



DE Das Design von Kalin Gemignani orientiert sich an einer synthetischen Sprache, die zeitgenössischen Lebensstil interpretiert: Form und Funktion definieren sich gegenseitig; die Linearität des Zeichens setzt sie in konkrete Elemente um, genau wie es bei der Leuchte Zeta der Fall ist: für die Herstellung aus BETALY® entwickelt, einem matten Material, das externen Witterungseinflüssen widersteht und sich im Laufe der Zeit in die Umgebung integriert, in der sie eingefügt wurde. Die einzigartige und schlanke Form machen Zeta ideal für jeden Außenbereich.

FR Le design de Kalin Gemignani est axé sur un langage synthétique, qui interprète des styles de vie contemporains: forme et fonction se définissent mutuellement ; c'est la linéarité du signe qui les traduit en éléments concrets, précisément comme cela s'est produit pour la lampe Zeta: conçue pour être réalisée en BETALY®, un matériau mat qui résiste aux agents atmosphériques et évolue dans le temps en s'intégrant au contexte dans lequel il s'insère. La forme unique et élancée fait de Zeta un produit idéal pour tout espace extérieur.

ZETA



Zeta esalta le caratteristiche di BETALY®, che diventa trasparente emettendo due fasci luminosi che illuminano il contesto circostante, creando scenografie notturne che rendono unico l'ambiente in cui è inserita.

Halim Sinigaglia

EN Zeta showcases the characteristics of BETALY®, which becomes transparent as it emits two bands of light to illuminate the surroundings, creating a nocturnal ambience which makes its setting unique.

DE Zeta hebt die Eigenschaften von BETALY® hervor, das transparent wird und zwei Lichtstrahlen abgibt, die den umliegenden Kontext beleuchten und Nachtszenen schaffen, die die Umgebung einzigartig gestalten.

FR Zeta met l'accent sur les caractéristiques de BETALY®, qui devient transparent en émettant deux faisceaux lumineux qui éclairent l'espace environnant, en créant des scénographies nocturnes qui rendent les lieux uniques.

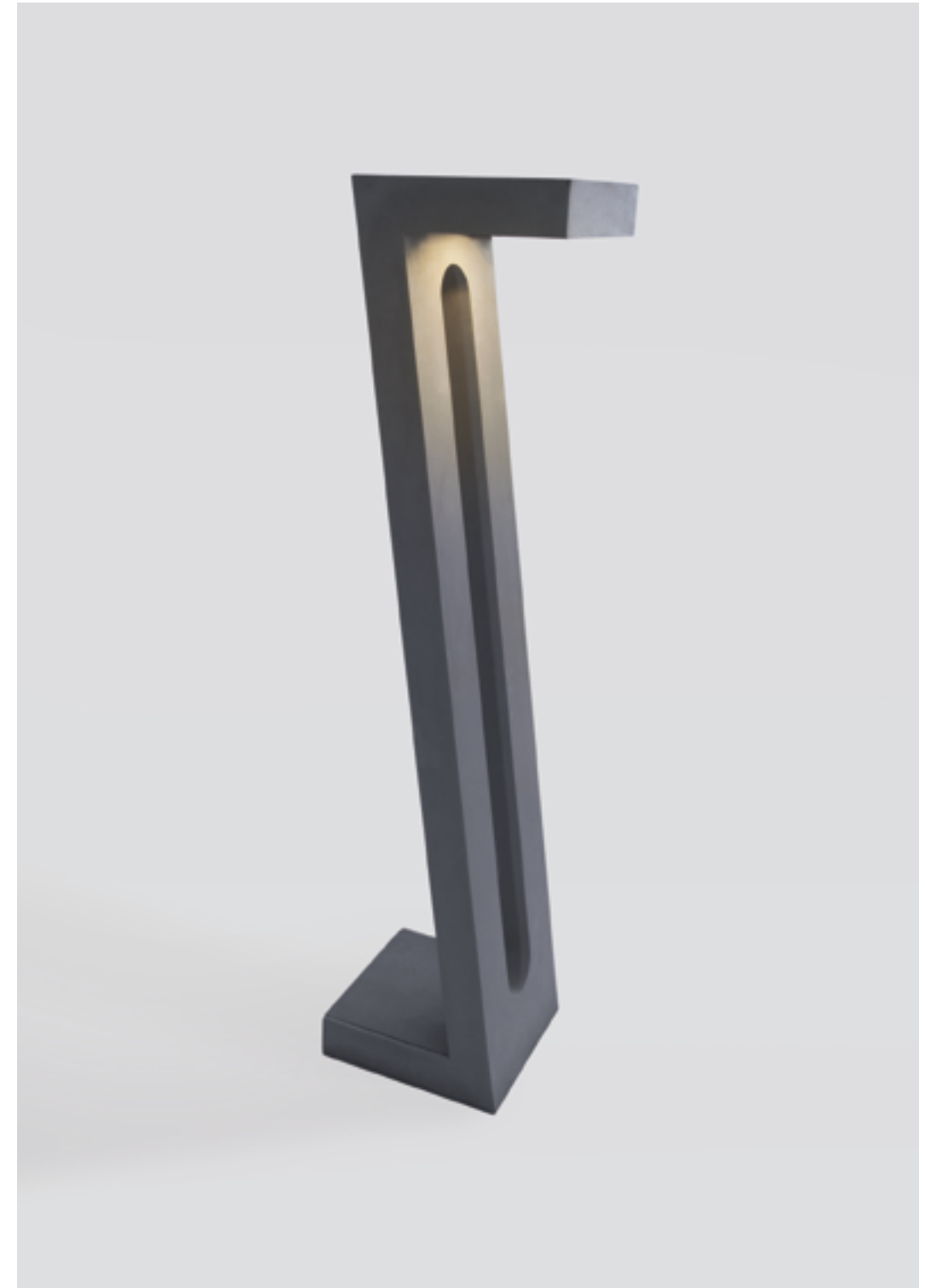

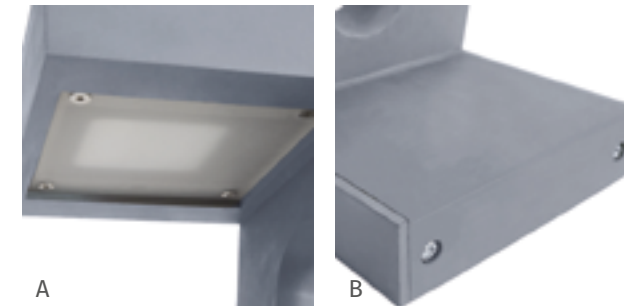
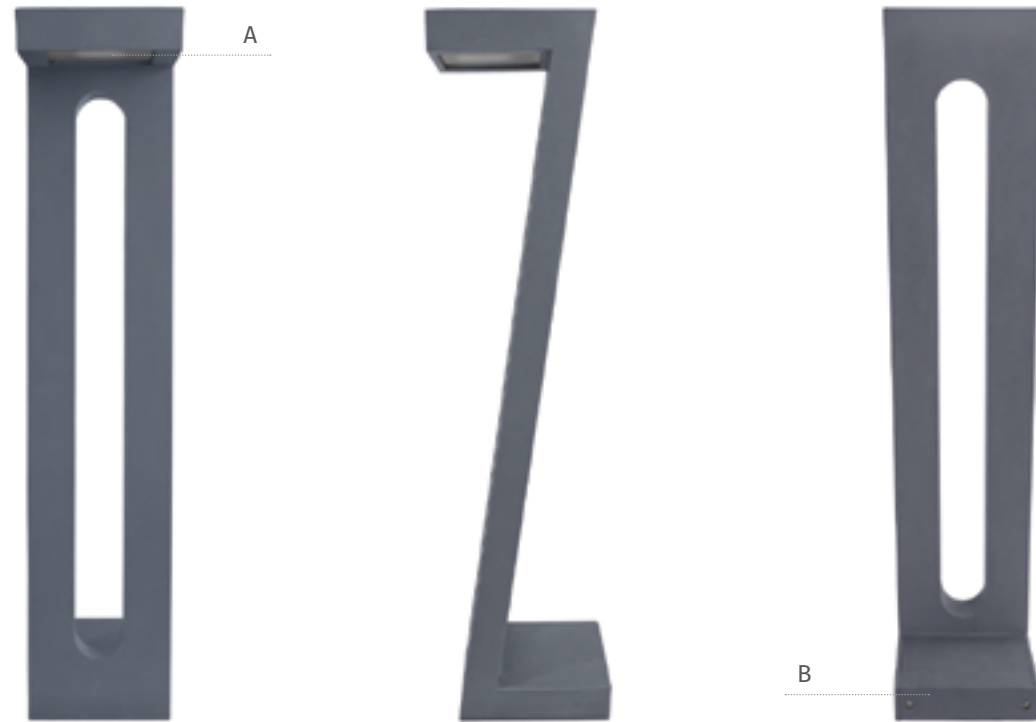
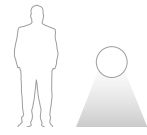

A: Vetro temperato acidato / Tempered etched glass / Geätztes gehärtetes Glas / Verre trempé satiné
 B: Coperchio per vano cablaggio e ancoraggio / Wiring and ground anchor compartment cover / Kabelanschlussraum und Bodenanker Sockel / Couvercle du compartiment électrique et de l'encrage au sol

Colori dei materiali / Colors of the materials
 Farben der Materialien / Couleurs des matériaux



392 Bianco / White
 Weiss / Blanc
 393 Verde / Green
 Grün / Vert
 394 Corten
 395 Grigio / Grey
 Grau / Gris
 396 Nero / Black
 Schwarz / Noir

Codice articolo* / Article Code* **1108A-396-30159**
 Grado di protezione / Protection degree / Schutzart / Degré de protection **IP65**
 Classe di isolamento / Insulation Class / Schutzklasse / Classe d'isolation **I**
 Potenza / Power / Leistung / Puissance **LED 10W**
 Tensione / Tension / Spannung / Tension **220-240V**
 Tonalità / Colour temperature / Farbtemperatur / Température de couleur **3000°K**
 Lumen **800lm**
 CRI **80**
 Colori dei materiali* / Colors of the materials* / Farben der Materialien* / Couleurs des matériaux* **392 393 394 395 396**

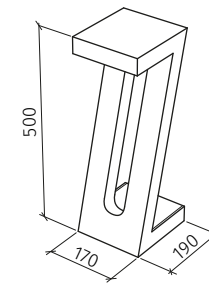

7,5 Kg

Alimentatore incluso / Power Supply included / Inklusive Betriebsgerät / Alimentation incluse

Codice articolo* / Article Code* **1108B-396-30159**
 Grado di protezione / Protection degree / Schutzart / Degré de protection **IP65**
 Classe di isolamento / Insulation Class / Schutzklasse / Classe d'isolation **I**
 Potenza / Power / Leistung / Puissance **LED 10W**
 Tensione / Tension / Spannung / Tension **220-240V**
 Tonalità / Colour temperature / Farbtemperatur / Température de couleur **3000°K**
 Lumen **800lm**
 CRI **80**
 Colori dei materiali* / Colors of the materials* / Farben der Materialien* / Couleurs des matériaux* **392 393 394 395 396**

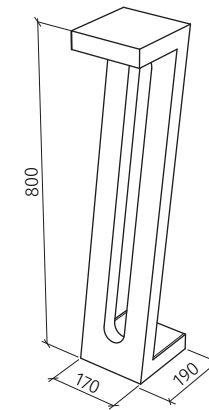

12 Kg

Alimentatore incluso / Power Supply included / Inklusive Betriebsgerät / Alimentation incluse

IT Misure espresse in mm, tolleranza +/- 1-2 mm. L'azienda si riserva la facoltà di apportare variazioni di dati caratteristici, materiali, design, stili, tonalità, senza alcun preavviso.
 EN Measures in mm, tolerance +/- 1/2 mm. The company reserves the right to carry out variations to technical details, materials, design, style, colors with no previous notice.

DE Die Masse sind in mm, mit einer Tolleranz von +/- 1-2 mm ausgedrückt, Die Firma behält sich das Recht vor ohne Voranmeldung Änderungen an den Werkstoffen, am Design, am Stil und an der Färbung vorzunehmen.
 FR Mesures en mm, tolérance +/- 1/2 mm. La société se réserve le droit de modifier sans préavis les détails techniques, les matériaux, le design, le style et les couleurs.

1108B-394-30159 / 1108B-396-30159



Alberto Ghirardello

Alberto Ghirardello è un product designer originario di Vicenza che attualmente vive e lavora a Milano dove ha maturato alcuni anni di esperienza all'interno di diversi studi professionali e nel 2013 fonda il proprio studio di progettazione, occupandosi di design a 360° e collaborando con numerose aziende ed istituzioni, sia italiane che estere.

EN Alberto Ghirardello is a Vicenza-born product designer who currently lives and works in Milan, where he gained several years' experience in several professional design studios and in 2013 founded his own studio, focusing on every aspect of design and collaborating with a number of firms and institutes both in Italy and abroad.

DE Alberto Ghirardello ist ein Produktdesigner aus Vicenza, der derzeit in Mailand lebt und arbeitet, wo er einige Jahre Erfahrung in verschiedenen professionellen Studios gesammelt hat und im Jahr 2013 sein eigenes Designstudio gegründet hat, sich um 360° mit Design beschäftigt und mit zahlreichen Unternehmen und Institutionen im In- und Ausland zusammenarbeitet.

FR Alberto Ghirardello est un product designer originaire de Vicence, actuellement il vit et travaille à Milan où il s'est forgé quelques années d'expérience au sein de divers cabinets professionnels; en 2013 il fonde son propre bureau de conception en se chargeant de design à 360° et en travaillant en collaboration avec de nombreuses entreprises et institutions italiennes et d'autres pays.

Alberto Ghirardello





Buona parte del mio lavoro nasce da un'attenta osservazione del quotidiano, della vita di tutti i giorni. Mi piace analizzare il comportamento umano per individuare piccoli problemi da risolvere con soluzioni semplici, pratiche e soprattutto gradevoli alla vista. Il binomio forma - funzione è ormai dato per assodato, bisogna iniziare a considerare un terzo valore e ragionare in termini di forma - funzione - emozione. Gli oggetti, per loro natura, sono un'istanza passiva, ma alcuni hanno una carica empatica che non li rende tali: in quello che faccio mi piace infondere un elemento poetico, emozionante, un qualcosa capace di generare sorpresa, ironia o semplice simpatia che faccia vibrare il prodotto di vita propria, anche se solo per un attimo.

EN *Much of my work comes from a careful observation of everyday life. I study human behaviour to identify small problems, which require simple and practical solutions, but most of all aesthetically pleasing to the eye.*

The binomial form/function is now taken for granted; we must begin to consider a third value and think in terms of form/function/emotion. By their nature, objects are passive entities, although some have an empathetic attitude that makes them different. I put poetry, emotion, amazement in what I do, sometimes just irony or kindness, and contrive to fill the product with a life-breath of its own, even if only for a moment.



DE *Ein Großteil meiner Arbeit beruht auf einer aufmerksamen Beobachtung des Alltags, des täglichen Lebens. Ich analysiere gerne das menschliche Verhalten, um kleine Probleme zu entdecken, die mit einfachen, praktischen und vor allem ästhetischen Lösungen gelöst werden können. Das Binom Form - Funktion ist bereits eine Voraussetzung, wir müssen anfangen, einen dritten Wert in Betracht zu ziehen und in Form - Funktion - Emotion denken.*

Objekte sind von Natur aus passive Instanzen, aber einige haben eine empathische Ladung, die sie anders aussehen lässt: in meine Arbeit lasse ich gerne ein poetisches, aufregendes Element einfließen, etwas, das Überraschung, Ironie oder einfach Sympathie hervorruft und das Produkt vibrieren lässt, wenn auch nur für einen kurzen Moment.

FR *Une grande partie de mon travail découle d'une observation attentive de la vie quotidienne. J'aime analyser le comportement humain pour résoudre les petits problèmes en apportant des solutions simples, pratiques et surtout agréables à l'œil. Le binôme forme - fonction étant maintenant supposé comme acquis, nous devons commencer à prendre en considération une troisième valeur et penser en termes de forme - fonction - émotion.*

Par leur nature, les objets sont une instance passive. Toutefois, certains ont une charge empathique qui ne les rend pas tels. Dans ce que je fais, j'aime insuffler un élément poétique et excitant, quelque chose capable de créer de la surprise, de l'ironie ou une simple sympathie qui fait vibrer le produit, qui lui donne de la vie, ne serait-ce que pour un instant.

BEAN



La forma di Bean è stata ottenuta per sottrazione: una sommità a tutto tondo, funzionale alla defluizione dell'acqua piovana, diventa forma generatrice per l'intaglio simmetrico dentro la quale trova posto la sorgente luminosa.

Alberto Perinetti

EN The shape of Bean was obtained through subtraction: the completely rounded top, ideal for shedding rainwater, becomes the template for symmetrical cut-outs which house the light sources.

DE Die Form von Bean wurde durch Subtraktion erhalten: ein runde Oberseite, die den Abfluss des Regenwassers ermöglicht, wird zum Ausgangspunkt für den symmetrischen Schnitt, in dem sich die Lichtquelle befindet.

FR La forme de Bean a été obtenue par soustraction : un sommet en ronde-bosse, laissant l'eau de pluie s'écouler, devient une forme génératrice avec l'entaille symétrique dans laquelle est positionnée la source lumineuse.



Paletti e segnapassi / Bollard and pathmarkers /
Pollerleuchten und orientierungsbeleuchtung / Bornes et balisages

CE BETALY® 9010 made in Italy

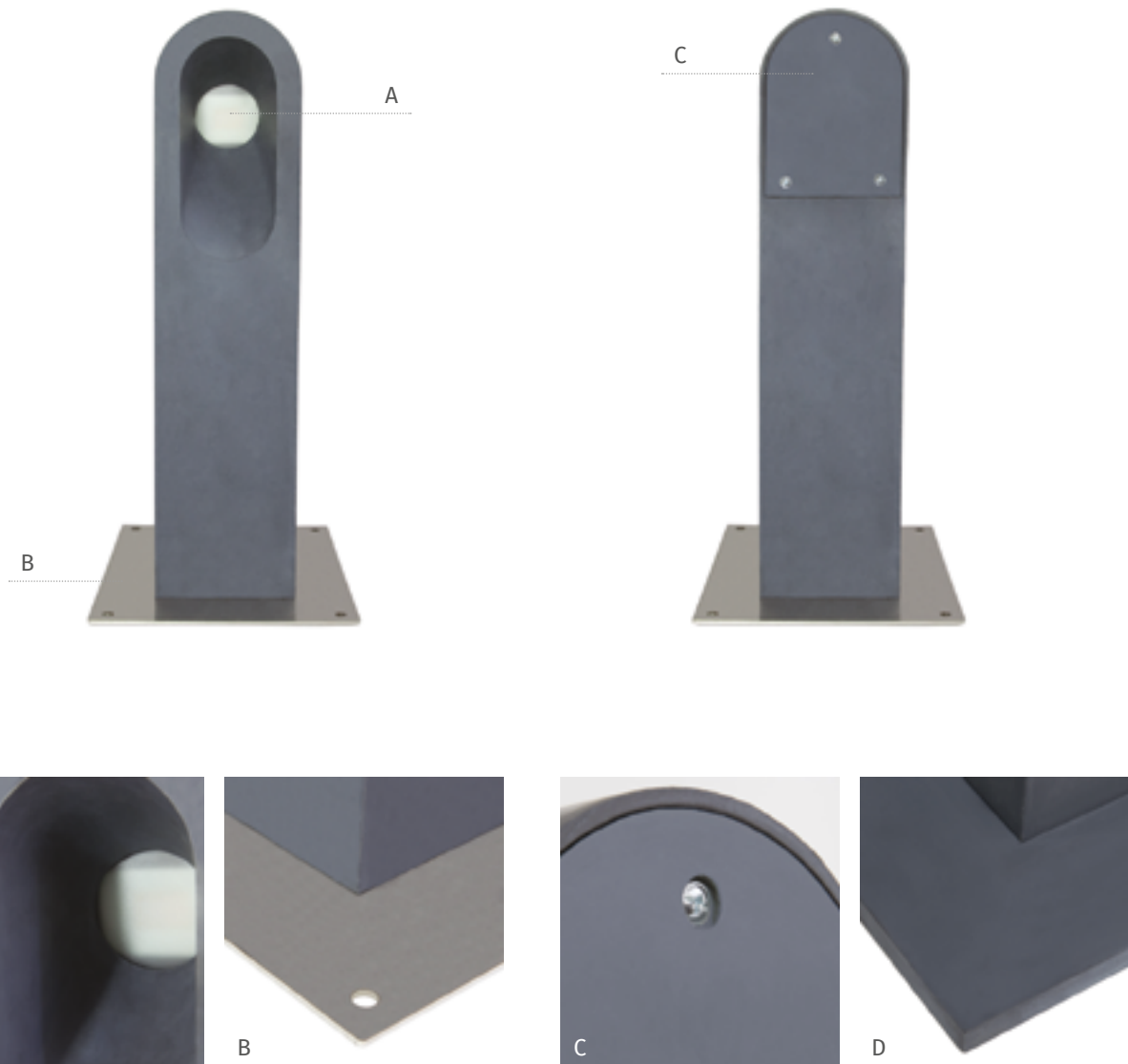
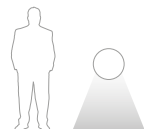

A: Vetro temperato acidato / Tempered etched glass / Geätztes gehärtetes Glas / Verre trempé
 B: Base in acciaio / Steel Base / Fuß aus Stahl / Base en acier
 C: Coperchio per vano cablaggio / Wiring compartment cover / Kabelanschlussraum Sockel / Couvercle du compartiment électrique
 D: Copri base in BETALY® (p. 148) / Cover-base in BETALY® (p. 148) / Sockel aus BETALY® (p. 148) / Couverture de la base en BETALY® (p. 148)

Colori dei materiali / Colors of the materials
Farben der Materialien / Couleurs des matériaux



392 Bianco / White / Weiss / Blanc
 393 Verde / Green / Grün / Vert
 394 Corten
 395 Grigio / Grey / Grau / Gris
 396 Nero / Black / Schwarz / Noir

Codice articolo* / Article Code* **1105A-396-3012**
 Grado di protezione / Protection degree / Schutzart / Degré de protection **IP65**
 Classe di isolamento / Insulation Class / Schutzklasse / Classe d'isolation **I**
 Potenza / Power / Leistung / Puissance **LED 10W**
 Tensione / Tension / Spannung / Tension **170-265V**
 Tonalità / Colour temperature / Farbtemperatur / Température de couleur **3000°K**
 Lumen **800lm**
 CRI **80**
 Colori dei materiali* / Colors of the materials* / Farben der Materialien* / Couleurs des matériaux* **392 393 394 395 396**

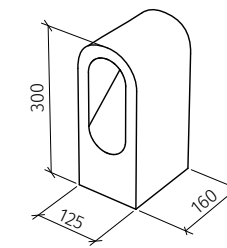

7 Kg

Alimentatore incluso / Power Supply included / Inklusive Betriebsgerät / Alimentation incluse

Codice articolo* / Article Code* **1105B-396-3012**
 Grado di protezione / Protection degree / Schutzart / Degré de protection **IP65**
 Classe di isolamento / Insulation Class / Schutzklasse / Classe d'isolation **I**
 Potenza / Power / Leistung / Puissance **LED 10W**
 Tensione / Tension / Spannung / Tension **170-265V**
 Tonalità / Colour temperature / Farbtemperatur / Température de couleur **3000°K**
 Lumen **800lm**
 CRI **80**
 Colori dei materiali* / Colors of the materials* / Farben der Materialien* / Couleurs des matériaux* **392 393 394 395 396**

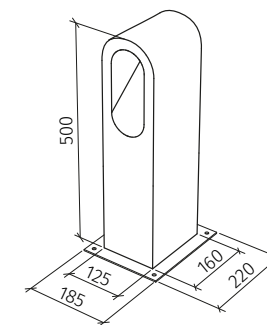

15 Kg

Alimentatore incluso / Power Supply included / Inklusive Betriebsgerät / Alimentation incluse

Codice articolo* / Article Code* **1105C-396-3012**
 Grado di protezione / Protection degree / Schutzart / Degré de protection **IP65**
 Classe di isolamento / Insulation Class / Schutzklasse / Classe d'isolation **I**
 Potenza / Power / Leistung / Puissance **LED 10W**
 Tensione / Tension / Spannung / Tension **170-265V**
 Tonalità / Colour temperature / Farbtemperatur / Température de couleur **3000°K**
 Lumen **800lm**
 CRI **80**
 Colori dei materiali* / Colors of the materials* / Farben der Materialien* / Couleurs des matériaux* **392 393 394 395 396**

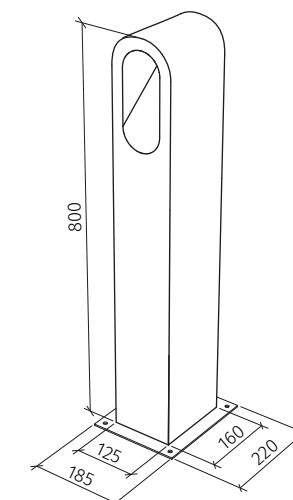

22,5 Kg

Alimentatore incluso / Power Supply included / Inklusive Betriebsgerät / Alimentation incluse

IT Misure espresse in mm, tolleranza +/- 1-2 mm. L'azienda si riserva la facoltà di apportare variazioni di dati caratteristici, materiali, design, stili, tonalità, senza alcun preavviso.

EN Measures in mm, tolerance +/- 1/2 mm. The company reserves the right to carry out variations to technical details, materials, design, style, colors with no previous notice.

DE Die Masse sind in mm, mit einer Tolleranz von +/- 1-2 mm ausgedrückt, Die Firma behält sich das Recht vor ohne Voranmeldung Änderungen an den Werkstoffen, am Design, am Stil und an der Färbung vorzunehmen.

FR Mesures en mm, tolérance +/- 1/2 mm. La société se réserve le droit de modifier sans préavis les détails techniques, les matériaux, le design, le style et les couleurs.

1105A-396-3012



1105A-392-3012 / 1105B-392-3012 / 1105C-392-3012



DOMINO



Domino è realizzata in BETALY® con delle forme geometriche pure e rigorose ed è composta da due distinti elementi, peculiarità che permette di offrire il prodotto anche in versione bicolore.

Alberto Perinetti

EN Domino is made in BETALY® with pure, austere geometric lines, and consists of two distinct elements, which means the lamp can also be produced in a two-colour version.

DE Domino ist aus BETALY® mit reinen und strengen geometrischen Formen gefertigt und besteht aus zwei unterschiedlichen Elementen, eine Besonderheit, die es ermöglicht, das Produkt auch in zweifarbiger Version anzubieten.

FR Domino est en BETALY® avec des formes géométriques pures et rigoureuses, et se compose de deux éléments séparés, une particularité qui permet de proposer le produit aussi en version bicolore.



A parete / Wall lighting / Wandleuchten / Appliques



BETALY®
9010

made in Italy



Codice articolo* / Article Code* **1104A-396-3012 + 1104Q-396**

Grado di protezione / Protection degree **IP65**
Schutzart / Degré de protection

Classe di isolamento / Insulation Class **I**
Schutzklasse / Classe d'isolation

Potenza / Power **LED 10W**
Leistung / Puissance

Tensione / Tension **170-265V**
Spannung / Tension

Tonalità / Colour temperature **3000°K**
Farbtemperatur / Température de couleur

Lumen **800lm**

CRI **80**

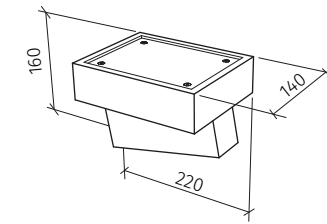

Colori dei materiali* / Colors of the materials*
Farben der Materialien* / Couleurs des matériaux* **392 393 394 395 396**

2,6 Kg

Alimentatore incluso / Power Supply included / Inklusive Betriebsgerät / Alimentation incluse

Componibile in due colorazioni / Modular in two colours / Modularesystem auf zwei Farben / Modulable en deux couleurs

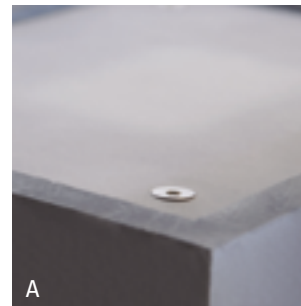

A: Vetro temperato acidato / Tempered etched glass / Geätztes gehärtetes Glas / Verre trempé satiné

CODE: 1104A-396-3012

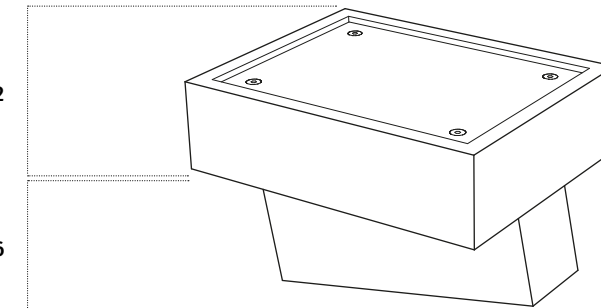

CODE: 1104Q-396

Esempio / Example

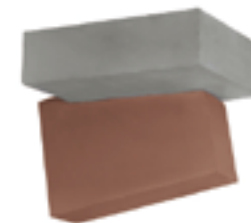

CODE: 1104A-395-3012 + 1104Q-394

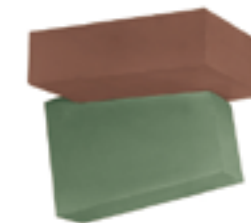

CODE: 1104A-394-3012 + 1104Q-393



CODE: 1104A-396-3012 + 1104Q-392

Colori dei materiali / Colors of the materials
Farben der Materialien / Couleurs des matériaux



392
Bianco / White
Weiss / Blanc



393
Verde / Green
Grün / Vert



394
Corten



395
Grigio / Grey
Grau / Gris



396
Nero / Black
Schwarz / Noir

IT Misure espresse in mm, tolleranza +/- 1-2 mm. L'azienda si riserva la facoltà di apportare variazioni di dati caratteristici, materiali, design, stili, tonalità, senza alcun preavviso.

EN Measures in mm, tolerance +/- 1/2 mm. The company reserves the right to carry out variations to technical details, materials, design, style, colors with no previous notice.

DE Die Masse sind in mm, mit einer Tolleranz von +/- 1-2 mm ausgedrückt, Die Firma behält sich das Recht vor ohne Voranmeldung Änderungen an den Werkstoffen, am Design, am Stil und an der Färbung vorzunehmen.

FR Mesures en mm, tolérance +/- 1/2 mm. La société se réserve le droit de modifier sans préavis les détails techniques, les matériaux, le design, le style et les couleurs.

1104A-394-3012 + 1104Q-394



1104A-394-3012 + 1104Q-394

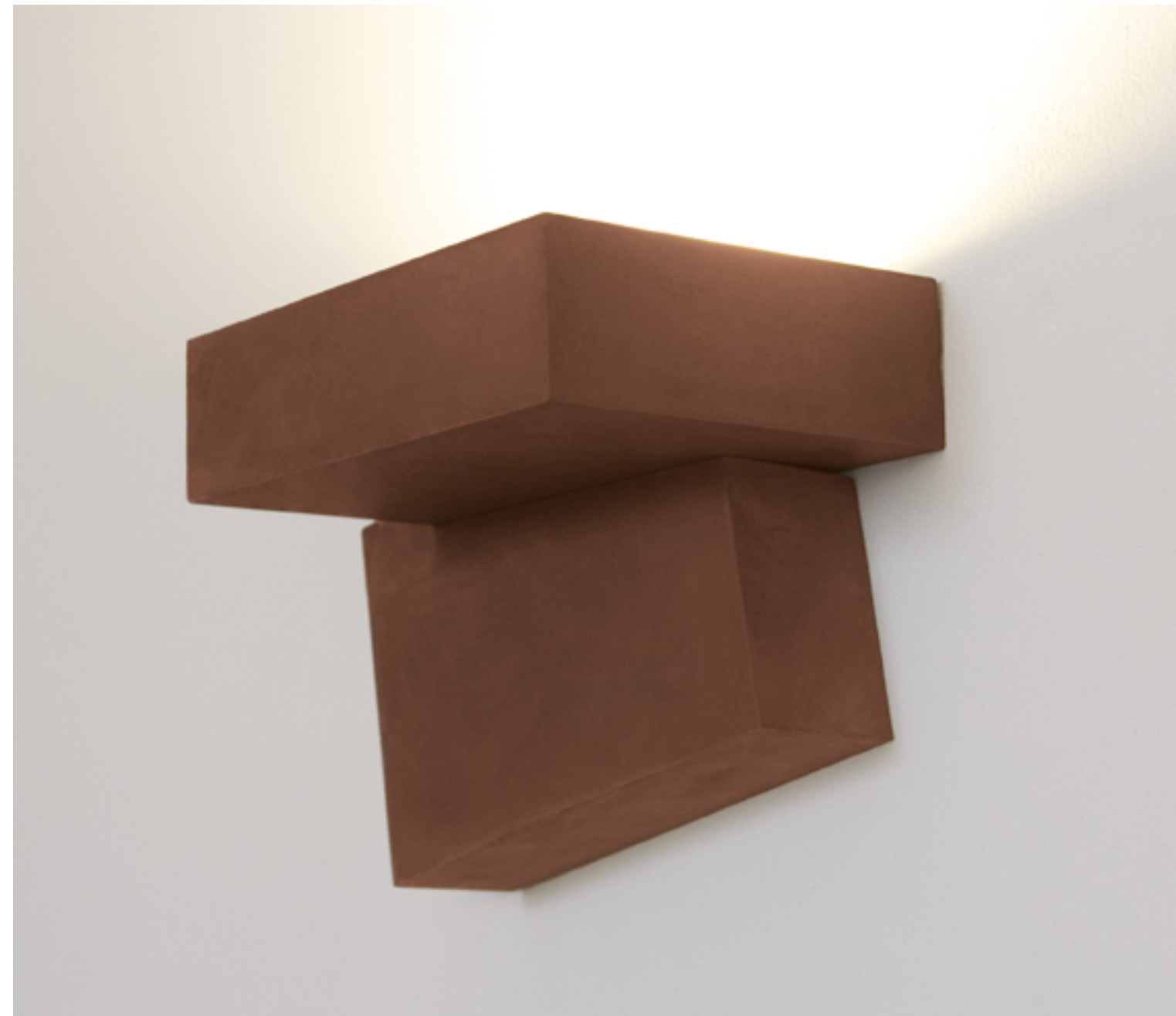

MINÙ



Minù è realizzata in BETALY® dalle forme che esaltano le possibilità di impiego del materiale ed è composta da due distinti elementi, peculiarità che permette di offrire il prodotto anche in versione bicolore.

EN Minù is made in BETALY® in a shape which showcases the potential of the material, and consists of two distinct elements, which means the lamp can also be produced in a two-colour version.

DE Minù ist aus BETALY® gefertigt mit Formen, die die Verwendungsmöglichkeit des Materials hervorheben und besteht aus zwei unterschiedlichen Elementen, eine Besonderheit, die es ermöglicht, das Produkt auch in zweifarbiger Version anzubieten.

FR Minù est en BETALY® avec des formes qui étendent les possibilités d'utilisation du matériau et se compose de deux éléments séparés, une particularité qui permet de proposer le produit aussi en version bicolore.



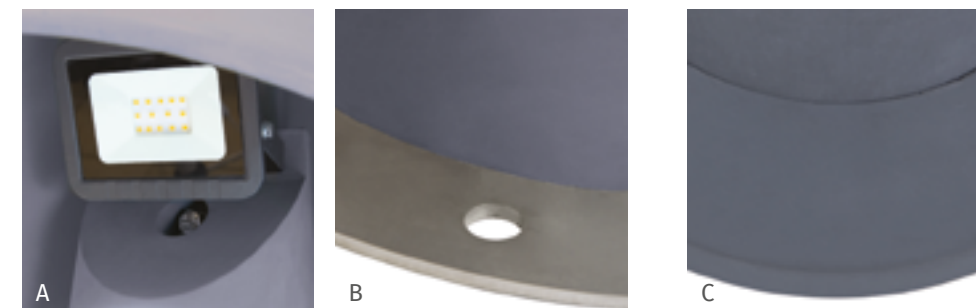
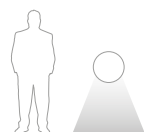

A: Faretto orientabile / Tilttable Light / Schwenkbare Leuchte / Lampe orientable

B: Base in acciaio / Steel Base / Fuß aus Stahl / Base en acier

C: Copri base in BETALY® (p. 148) / Cover-base in BETALY® (p. 148) / Sockel aus BETALY® (p. 148) / Couverture de la base en BETALY® (p. 148)

Colori dei materiali / Colors of the materials
Farben der Materialien / Couleurs des matériaux



392
Bianco / White
Weiss / Blanc

393
Verde / Green
Grün / Vert

394
Corten

395
Grigio / Grey
Grau / Gris

396
Nero / Black
Schwarz / Noir

Codice articolo* / Article Code* **1106A-396-3012 + 1106Q-396**

Grado di protezione / Protection degree **IP65**
Schutzart / Degré de protection

Classe di isolamento / Insulation Class **I**
Schutzklasse / Classe d'isolation

Potenza / Power **LED 10W**
Leistung / Puissance

Tensione / Tension **170-265V**
Spannung / Tension

Tonalità / Colour temperature **3000°K**
Farbtemperatur / Température de couleur

Lumen **800lm**

CRI **80**

Colori dei materiali* / Colors of the materials*
Farben der Materialien* / Couleurs des matériaux*
392 393 394 395 396

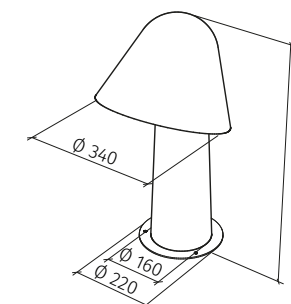

21 Kg

Alimentatore incluso / Power Supply included / Inklusive Betriebsgerät / Alimentation incluse

Componibile in due colorazioni / Modular in two colours / Modulare system auf zwei Farben / Modulable en deux couleurs

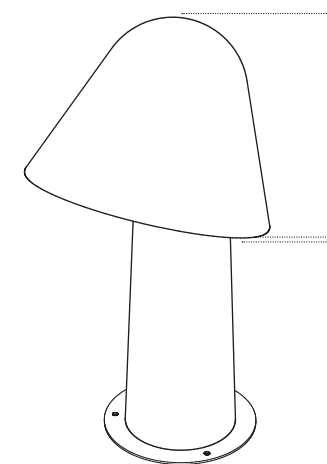

CODE: 1106Q-396

CODE: 1106A-396-3012

Esempio / Example



CODE: 1106A-394-3012 + 1106Q-395



CODE: 1106A-393-3012 + 1106Q-394



CODE: 1106A-392-3012 + 1106Q-396

IT Misure espresse in mm, tolleranza +/- 1-2 mm. L'azienda si riserva la facoltà di apportare variazioni di dati caratteristici, materiali, design, stili, tonalità, senza alcun preavviso.

EN Measures in mm, tolerance +/- 1/2 mm. The company reserves the right to carry out variations to technical details, materials, design, style, colors with no previous notice.

DE Die Masse sind in mm, mit einer Tolleranz von +/- 1-2 mm ausgedrückt, Die Firma behält sich das Recht vor ohne Voranmeldung Änderungen an den Werkstoffen, am Design, am Stil und an der Färbung vorzunehmen.

FR Mesures en mm, tolérance +/- 1/2 mm. La société se réserve le droit de modifier sans préavis les détails techniques, les matériaux, le design, le style et les couleurs.

1106A-395-3012 + 1106Q-395



1106A-393-3012 + 1106Q-395 / 1106A-395-3012 + 1106Q-393



HENRY & CO.

HENRY & CO. è uno studio di design di Verona nato nel 2013 che progetta con la convinzione che l'unico futuro possibile sia la sostenibilità. Lo scopo di HENRY & CO. è quello di supportare le aziende nella progettazione e ri-progettazione sia di prodotti che di servizi comunicativi puntando ad un'economia circolare.

EN HENRY & CO. is a Verona design studio founded in 2013 with the belief that sustainability is the only way forward. The aim of HENRY & CO is to support firms in the design and re-design of both products and communication services, aiming for a circular economy.

DE HENRY & CO. ist ein im Jahr 2013 gegründetes Designstudio in Verona, das mit der Überzeugung entwirft, dass Nachhaltigkeit, die einzig mögliche Zukunft ist. Der Zweck von HENRY & CO. Ist der, Unternehmen bei der Gestaltung und Neugestaltung von Produkten und kommunikativen Dienstleistungen zu unterstützen, die eine Kreislaufwirtschaft anstreben.

FR HENRY & CO. est un bureau de design de Vérone créé en 2013 qui conçoit avec la conviction que le seul futur possible est la durabilité. Le but d'HENRY & CO. est de soutenir les entreprises dans la conception et la refonte de produits comme de services de communication en misant sur une économie circulaire.





Solido, strutturale e concreto seppur morbido, fluido ed astratto. Levico coniuga la sinuosità organica della curva alla solida presenza architettonica del BETALY® in un gioco di contrasti, un ossimoro di forma e materia che si sintetizza in un prodotto iconico e minimale. Ispirata alla lenta azione geomorfologica dei fiumi, Levico tratta la luce come un liquido, una forza erosiva in grado di dare essa stessa forma al corpo luminoso. A partire dalla cellula architettonica per eccellenza, la colonna, Levico lascia quindi che sia la luce a determinare la propria forma, rievocando in essa il romantico scontro tra forze naturali ed artificiali.

EN *Solid, structural and concrete yet soft, fluid and abstract. Levico combines the organic sinuousness of the curve with the solid architectural presence of BETALY® in a series of contrasts, an oxymoron of form and material which comes together in an iconic and minimal object. Inspired by the slow shaping action of rivers, Levico handles light as if it were liquid, an erosional force which can itself shape the body of the lamp. To do this, Levico begins with the quintessential architectural element - the column, and allows light to find its own shape, evoking the romantic encounter between the forces of nature and artifice.*

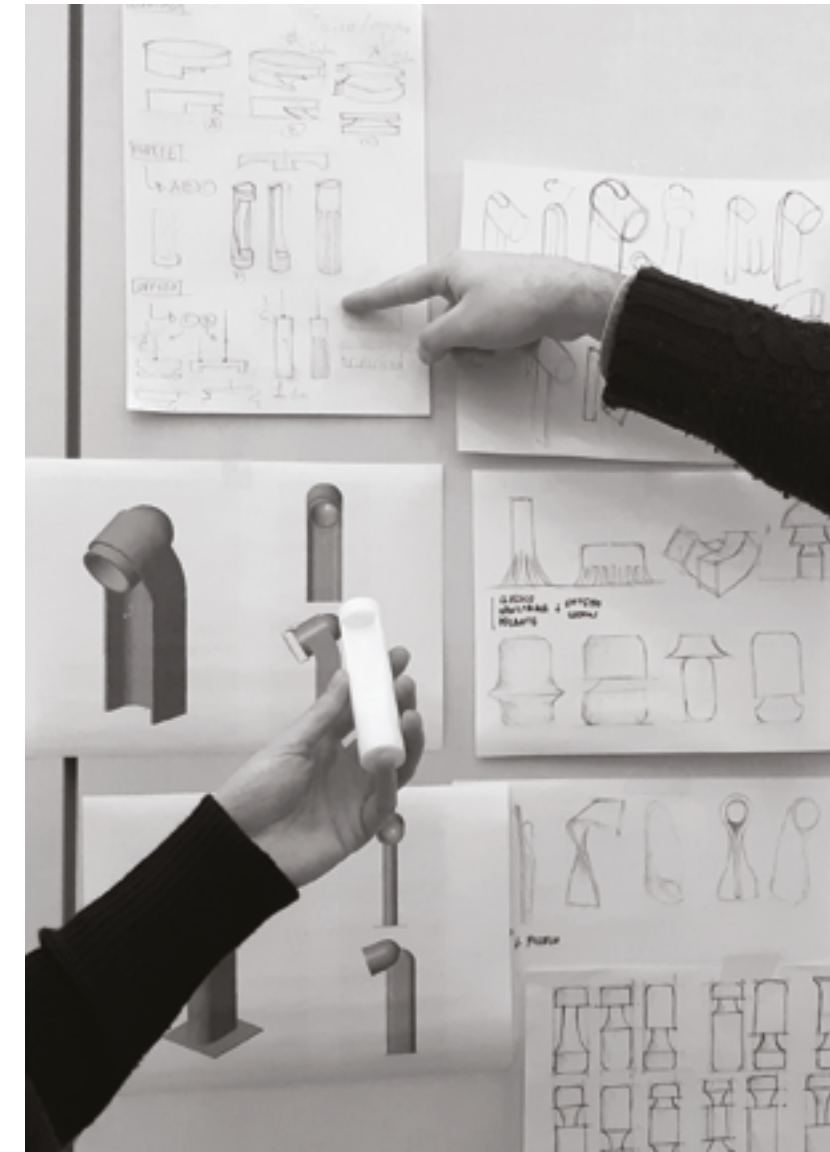

DE *Solide, strukturell und konkret, wenngleich weich, fließend und abstrakt. Levico kombiniert die organische Sinuosität der Kurven mit der soliden architektonischen Präsenz von BETALY® in einem Spiel der Kontraste, ein Widerspruch in Form und Material, der in einem ikonischen und minimalen Produkt zusammengefasst wird. Inspiriert von der langsamen geomorphologischen Bewegung der Flüsse, behandelt Levico das Licht wie eine Flüssigkeit, eine erosive Kraft, die in der Lage ist, dem Leuchtkörper Form zu verleihen. Ausgehend von der architektonischen Zelle schlechthin, lässt die Säule Levico das Licht seine eigene Form bestimmen und beschwört damit den romantischen Zusammenstoß zwischen natürlichen und künstlichen Kräften herauf.*

FR *Solide, structurel et concret bien que doux, fluide et abstrait. Levico conjugue la sinuosité organique de la courbe à la solide présence architecturale du BETALY® dans un jeu de contrastes, oxymore de forme et de matière qui se résume en un produit iconique et minimaliste. Inspiré de la lente action géomorphologique des fleuves, Levico traite la lumière comme un liquide, une force érosive qui donne la même forme au corps lumineux. À partir de la cellule architecturale par excellence, la colonne, Levico laisse donc la lumière déterminer sa forme, en ré-évoquant en elle la romantique opposition entre forces naturelles et artificielles.*

LEVICO



Come una sorgente d'alta quota, la fonte luminosa è isolata e celata e come l'acqua di un fiume, la luce scava il suo percorso attraverso il corpo luminoso, lasciandosi dietro conche ed avvallamenti che ne ammorbidiscono la diffusione.

*HT-Plus
Antonio D'Amico
Francesco Zucchi*

EN Like a mountain spring, the light source is isolated and concealed; like the water of a river, the light carves its course through the body of the lamp, leaving behind hollows and dips which soften the diffusion.

DE Wie eine Quelle in den Bergen ist die Lichtquelle isoliert und verborgen und wie das Wasser eines Flusses gräbt sich das Licht seinen Weg durch den Lichtkörper, wobei es Mulden und Vertiefungen hinterlässt, die seine Diffusion weicher machen.

FR Comme une source de haute altitude, la source lumineuse est isolée et masquée, et comme l'eau d'un fleuve, la lumière creuse son parcours à travers le corps lumineux, en s'immisçant derrière conques et profondeurs qui en adoucissent la diffusion.



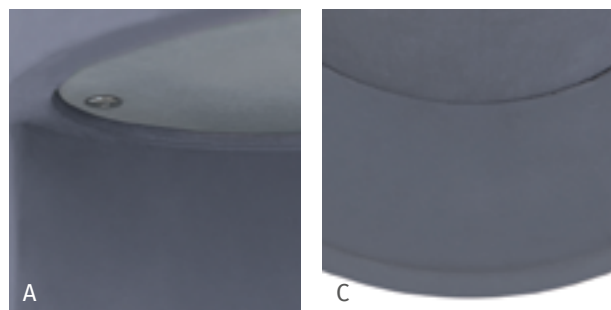
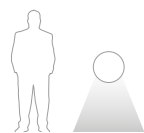

A: Vetro temperato acidato / Tempered etched glass / Geätztes gehärtetes Glas / Verre trempé satiné

B: Base in acciaio / Steel Base / Fuß aus Stahl / Base en acier

C: Copri base in BETALY® (p. 148) / Cover-base in BETALY® (p. 148) / Sockel aus BETALY® (p. 148) / Couverture de la base en BETALY® (p. 148)

Colori dei materiali / Colors of the materials
 Farben der Materialien / Couleurs des matériaux



392
 Bianco / White
 Weiss / Blanc

393
 Verde / Green
 Grün / Vert

394
 Corten

395
 Grigio / Grey
 Grau / Gris

396
 Nero / Black
 Schwarz / Noir

Codice articolo* / Article Code* **1110A-396-3012**

Grado di protezione / Protection degree / Schutzart / Degré de protection **IP65**

Classe di isolamento / Insulation Class / Schutzklasse / Classe d'isolation **I**

Potenza / Power / Leistung / Puissance **LED 10W**

Tensione / Tension / Spannung / Tension **170-265V**

Tonalità / Colour temperature / Farbtemperatur / Température de couleur **3000°K**

Lumen **800lm**

CRI **80**

Colori dei materiali* / Colors of the materials* / Farben der Materialien* / Couleurs des matériaux* **392 393 394 395 396**

Alimentatore incluso / Power Supply included / Inklusive Betriebsgerät / Alimentation incluse

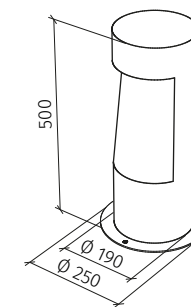

21 Kg

Codice articolo* / Article Code* **1110B-396-3012**

Grado di protezione / Protection degree / Schutzart / Degré de protection **IP65**

Classe di isolamento / Insulation Class / Schutzklasse / Classe d'isolation **I**

Potenza / Power / Leistung / Puissance **LED 10W**

Tensione / Tension / Spannung / Tension **170-265V**

Tonalità / Colour temperature / Farbtemperatur / Température de couleur **3000°K**

Lumen **800lm**

CRI **80**

Colori dei materiali* / Colors of the materials* / Farben der Materialien* / Couleurs des matériaux* **392 393 394 395 396**

Alimentatore incluso / Power Supply included / Inklusive Betriebsgerät / Alimentation incluse

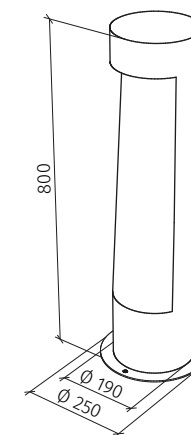

31 Kg

IT Misure espresse in mm, tolleranza +/- 1-2 mm. L'azienda si riserva la facoltà di apportare variazioni di dati caratteristici, materiali, design, stili, tonalità, senza alcun preavviso.

EN Measures in mm, tolerance +/- 1/2 mm. The company reserves the right to carry out variations to technical details, materials, design, style, colors with no previous notice.

DE Die Masse sind in mm, mit einer Tolleranz von +/- 1-2 mm ausgedrückt, Die Firma behält sich das Recht vor ohne Voranmeldung Änderungen an den Werkstoffen, am Design, am Stil und an der Färbung vorzunehmen.

FR Mesures en mm, tolérance +/- 1/2 mm. La société se réserve le droit de modifier sans préavis les détails techniques, les matériaux, le design, le style et les couleurs.

1110B-396-3012



A parete / Wall lighting / Wandleuchten / Appliques



BETALY®
9010

made in Italy



A

Codice articolo* / Article Code* **1098-396-30160**
 Grado di protezione / Protection degree / Schutzart / Degré de protection **IP65**
 Classe di isolamento / Insulation Class / Schutzklasse / Classe d'isolation **III**
 Potenza / Power / Leistung / Puissance **LED 6W**
 Tensione / Tension / Spannung / Tension **** 24Vdc**
 Tonalità / Colour temperature / Farbtemperatur / Température de couleur **3000°K**
 Lumen **800lm**
 CRI **80**

Colori dei materiali* / Colors of the materials* / Farben der Materialien* / Couleurs des matériaux*



5,5 Kg

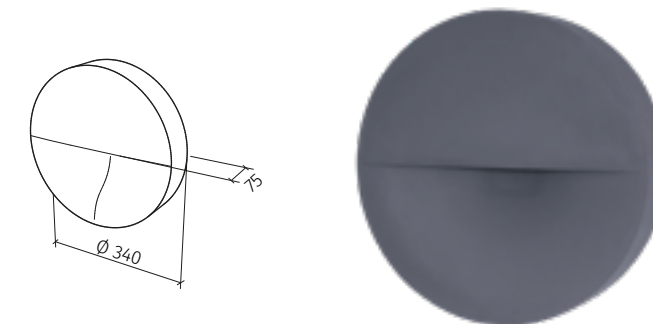

Alimentatore da ordinare separatamente / Power Supply to be ordered separately / Betriebsgerät separate zu bestellen / Alimentation à commander séparément

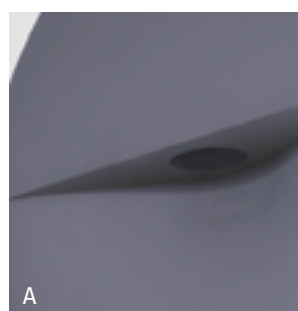

A: Direzione luce solo verso il basso / Light downwards only / Licht nur nach unten / Lumière seulement vers le bas

** Necessita di alimentatore remoto tensione costante / Remote constant voltage driver is required
 Benötigt externe Spannungsversorgung / Alimentateur à tension constante déporté nécessaire

Colori dei materiali / Colors of the materials
 Farben der Materialien / Couleurs des matériaux



392
 Bianco / White
 Weiss / Blanc

393
 Verde / Green
 Grün / Vert

394
 Corten

395
 Grigio / Grey
 Grau / Gris

396
 Nero / Black
 Schwarz / Noir

026.258



12W - 24Vdc
 IP20
 130x42x23mm
 ON/OFF
 IN 220-240V-

026.259



36W - 24Vdc
 IP20
 167x45x30mm
 ON/OFF
 IN 220-240V-

026.301



24W - 24Vdc
 IP20
 164x38x25mm
 DIM PUSH / DALI / 0-10V / 1-10V
 IN 220-240V-

IT Misure espresse in mm, tolleranza +/- 1-2 mm. L'azienda si riserva la facoltà di apportare variazioni di dati caratteristici, materiali, design, stili, tonalità, senza alcun preavviso.

EN Measures in mm, tolerance +/- 1/2 mm. The company reserves the right to carry out variations to technical details, materials, design, style, colors with no previous notice.

DE Die Masse sind in mm, mit einer Tolleranz von +/- 1-2 mm ausgedrückt, Die Firma behält sich das Recht vor ohne Voranmeldung Änderungen an den Werkstoffen, am Design, am Stil und an der Färbung vorzunehmen.

FR Mesures en mm, tolérance +/- 1/2 mm. La société se réserve le droit de modifier sans préavis les détails techniques, les matériaux, le design, le style et les couleurs.

1098-395-30160



1098-395-30160



9010® Design

Lo staff di 9010 si compone di professionisti dediti al proprio lavoro. Grazie alla lunga esperienza aziendale nel settore dell'illuminazione, mettiamo a punto creazioni originali ed eleganti, dal design rifinito e moderno. Abbiniamo tradizione, modernità, creatività, utilità, attenzione, sicurezza e design per illuminare i vostri spazi con ampia prospettiva artistica.

EN The staff at 9010 are professionals, and devoted to their work. Thanks to our long experience in the lighting sector, we are able to produce original, elegant creations with exquisite modern design. We combine tradition, modernity, creativity, functionality, attention to detail, safety and design to light up your spaces with artistic style.

DE Die Mitarbeiter von 9010 sind Profis, die sich mit Hingabe ihrer Arbeit widmen. Dank der langjährigen Unternehmensefahrung in der Beleuchtungsbranche werden originelle und elegante Kreationen mit raffiniertem und modernem Design entwickelt. Wir kombinieren Tradition, Moderne, Kreativität, Nützlichkeit, Aufmerksamkeit, Sicherheit und Design, um Ihre Räume mit breiter künstlerischer Perspektive zu beleuchten.

FR Le personnel de 9010 se compose de professionnels dévoués à leur travail. Forts de notre expérience dans le secteur de l'éclairage, nous mettons au point des créations originales et élégantes, au design moderne et abouti. Nous combinons tradition, modernité, créativité, utilité, attention, sécurité et design pour éclairer vos espaces avec une grande composante artistique.

Novantadiecì
9010



A parete / Wall lighting / Wandleuchten / Appliques

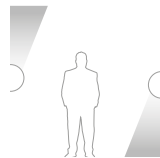

BETALY®
9010

made in Italy



Codice articolo* / Article Code* **1090-396-3012**

Grado di protezione / Protection degree / Schutzart / Degré de protection **IP65**

Classe di isolamento / Insulation Class / Schutzklasse / Classe d'isolation **I**

Potenza / Power / Leistung / Puissance **LED 10W**

Tensione / Tension / Spannung / Tension **170-265V**

Tonalità / Colour temperature / Farbtemperatur / Température de couleur **3000°K**

Lumen **800lm**

CRI **80**

Colori dei materiali* / Colors of the materials* / Farben der Materialien* / Couleurs des matériaux*

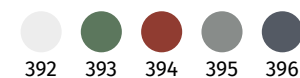

3,7 Kg

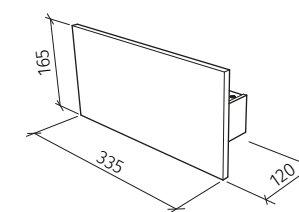

Alimentatore incluso / Power Supply included / Inklusive Betriebsgerät / Alimentation incluse

Colori dei materiali / Colors of the materials
Farben der Materialien / Couleurs des matériaux



392
Bianco / White
Weiss / Blanc



393
Verde / Green
Grün / Vert



394
Corten



395
Grigio / Grey
Grau / Gris



396
Nero / Black
Schwarz / Noir

IT Misure espresse in mm, tolleranza +/- 1-2 mm. L'azienda si riserva la facoltà di apportare variazioni di dati caratteristici, materiali, design, stili, tonalità, senza alcun preavviso.

EN Measures in mm, tolerance +/- 1/2 mm. The company reserves the right to carry out variations to technical details, materials, design, style, colors with no previous notice.

DE Die Masse sind in mm, mit einer Tolleranz von +/- 1-2 mm ausgedrückt, Die Firma behält sich das Recht vor ohne Voranmeldung Änderungen an den Werkstoffen, am Design, am Stil und an der Färbung vorzunehmen.

FR Mesures en mm, tolérance +/- 1/2 mm. La société se réserve le droit de modifier sans préavis les détails techniques, les matériaux, le design, le style et les couleurs.

1090-396-3012



1090-396-3012



A parete / Wall lighting / Wandleuchten / Appliques



BETALY®
9010

made in Italy

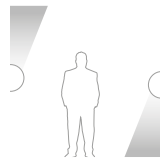

Codice articolo* / Article Code* **1091-396-3012**

Grado di protezione / Protection degree / Schutzart / Degré de protection **IP65**

Classe di isolamento / Insulation Class / Schutzklasse / Classe d'isolation **I**

Potenza / Power / Leistung / Puissance **LED 10W**

Tensione / Tension / Spannung / Tension **170-265V**

Tonalità / Colour temperature / Farbtemperatur / Température de couleur **3000°K**

Lumen **800lm**

CRI **80**

Colori dei materiali* / Colors of the materials* / Farben der Materialien* / Couleurs des matériaux*

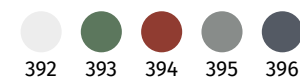

2,15 Kg

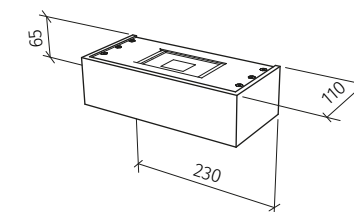

Alimentatore incluso / Power Supply included / Inklusive Betriebsgerät / Alimentation incluse



A: Staffa in acciaio inox satinato / Stainless satin steel Bracket / Halterung aus poliertem Edelstahl / Support en acier inoxydable satiné

Colori dei materiali / Colors of the materials
Farben der Materialien / Couleurs des matériaux



392
Bianco / White
Weiss / Blanc

393
Verde / Green
Grün / Vert

394
Corten

395
Grigio / Grey
Grau / Gris

396
Nero / Black
Schwarz / Noir

IT Misure espresse in mm, tolleranza +/- 1-2 mm. L'azienda si riserva la facoltà di apportare variazioni di dati caratteristici, materiali, design, stili, tonalità, senza alcun preavviso.

EN Measures in mm, tolerance +/- 1/2 mm. The company reserves the right to carry out variations to technical details, materials, design, style, colors with no previous notice.

DE Die Masse sind in mm, mit einer Tolleranz von +/- 1-2 mm ausgedrückt, Die Firma behält sich das Recht vor ohne Voranmeldung Änderungen an den Werkstoffen, am Design, am Stil und an der Färbung vorzunehmen.

FR Mesures en mm, tolérance +/- 1/2 mm. La société se réserve le droit de modifier sans préavis les détails techniques, les matériaux, le design, le style et les couleurs.

1091-396-3012



1091-396-3012

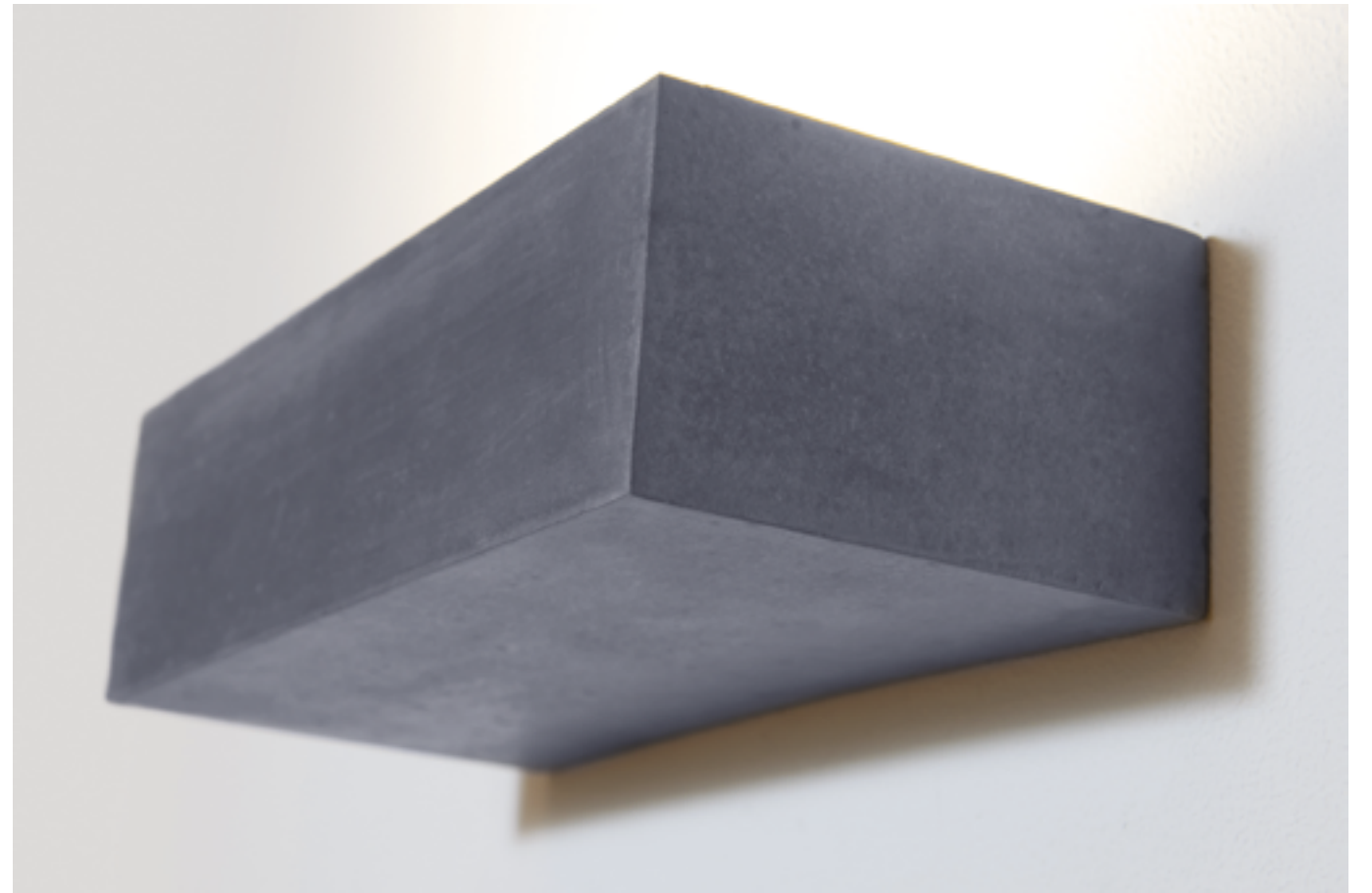

A parete / Wall lighting / Wandleuchten / Appliques

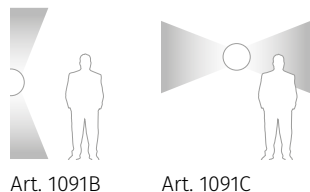

Art. 1091B

Art. 1091C

Art. 1091B



Art. 1091C

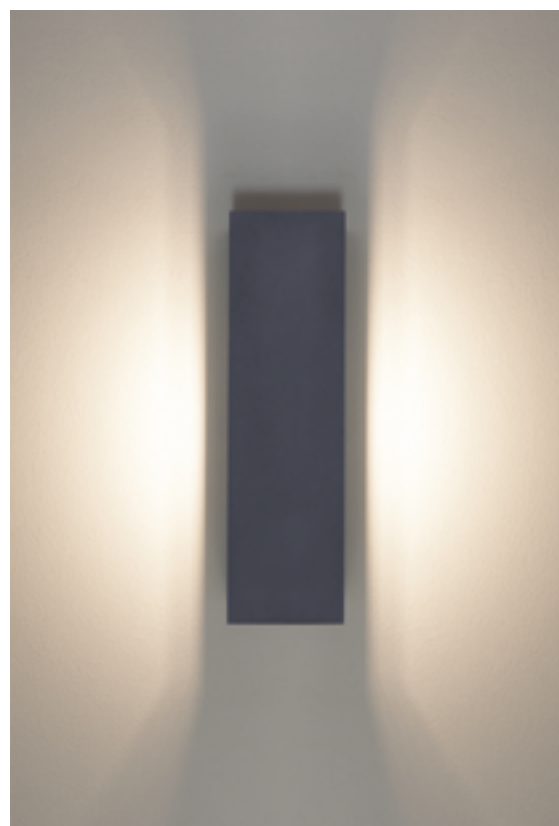

BETALY® 9010

made in Italy

Codice articolo* / Article Code* **1091B-396-30160**

Grado di protezione / Protection degree / Schutzart / Degré de protection **IP65**

Classe di isolamento / Insulation Class / Schutzklasse / Classe d'isolation **III**

Potenza / Power / Leistung / Puissance **LED 6W**

Tensione / Tension / Spannung / Tension **** 24Vdc**

Tonalità / Colour temperature / Farbtemperatur / Température de couleur **3000°K**

Lumen **800lm**

CRI **80**

Colori dei materiali* / Colors of the materials* / Farben der Materialien* / Couleurs des matériaux*

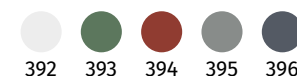

1,6 Kg

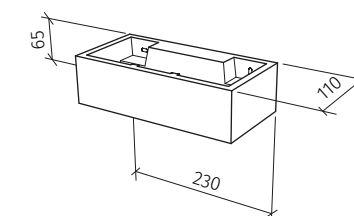

Alimentatore da ordinare separatamente / Power Supply to be ordered separately / Betriebsgerät separate zu bestellen / Alimentation à commander séparément

Codice articolo* / Article Code* **1091C-396-30160**

Grado di protezione / Protection degree / Schutzart / Degré de protection **IP65**

Classe di isolamento / Insulation Class / Schutzklasse / Classe d'isolation **III**

Potenza / Power / Leistung / Puissance **LED 6W**

Tensione / Tension / Spannung / Tension **** 24Vdc**

Tonalità / Colour temperature / Farbtemperatur / Température de couleur **3000°K**

Lumen **800lm**

CRI **80**

Colori dei materiali* / Colors of the materials* / Farben der Materialien* / Couleurs des matériaux*



1,6 Kg

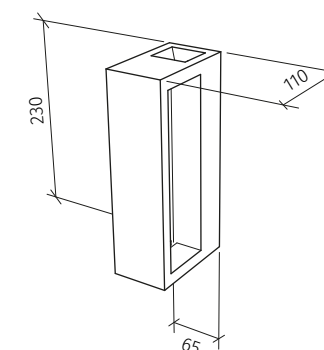

Alimentatore da ordinare separatamente / Power Supply to be ordered separately / Betriebsgerät separate zu bestellen / Alimentation à commander séparément

** Necessita di alimentatore remoto tensione costante / Remote constant voltage driver is required
Benötigt externe Spannungsversorgung / Alimentateur à tension constante déporté nécessaire

Colori dei materiali / Colors of the materials
Farben der Materialien / Couleurs des matériaux



392
Bianco / White
Weiss / Blanc

393
Verde / Green
Grün / Vert

394
Corten

395
Grigio / Grey
Grau / Gris

396
Nero / Black
Schwarz / Noir

026.258



12W - 24Vdc
IP20
130x42x23mm
ON/OFF
IN 220-240V-

026.259



36W - 24Vdc
IP20
167x45x30mm
ON/OFF
IN 220-240V-

026.301



24W - 24Vdc
IP20
164x38x25mm
DIM PUSH / DALI / 0-10V / 1-10V
IN 220-240V-

IT Misure espresse in mm, tolleranza +/- 1-2 mm. L'azienda si riserva la facoltà di apportare variazioni di dati caratteristici, materiali, design, stili, tonalità, senza alcun preavviso.

EN Measures in mm, tolerance +/- 1/2 mm. The company reserves the right to carry out variations to technical details, materials, design, style, colors with no previous notice.

DE Die Masse sind in mm, mit einer Tolleranz von +/- 1-2 mm ausgedrückt, Die Firma behält sich das Recht vor ohne Voranmeldung Änderungen an den Werkstoffen, am Design, am Stil und an der Färbung vorzunehmen.

FR Mesures en mm, tolérance +/- 1/2 mm. La société se réserve le droit de modifier sans préavis les détails techniques, les matériaux, le design, le style et les couleurs.

1091B-395-30160



1091C-395-30160



A parete / Wall lighting / Wandleuchten / Appliques



BETALY®
9010

made in Italy

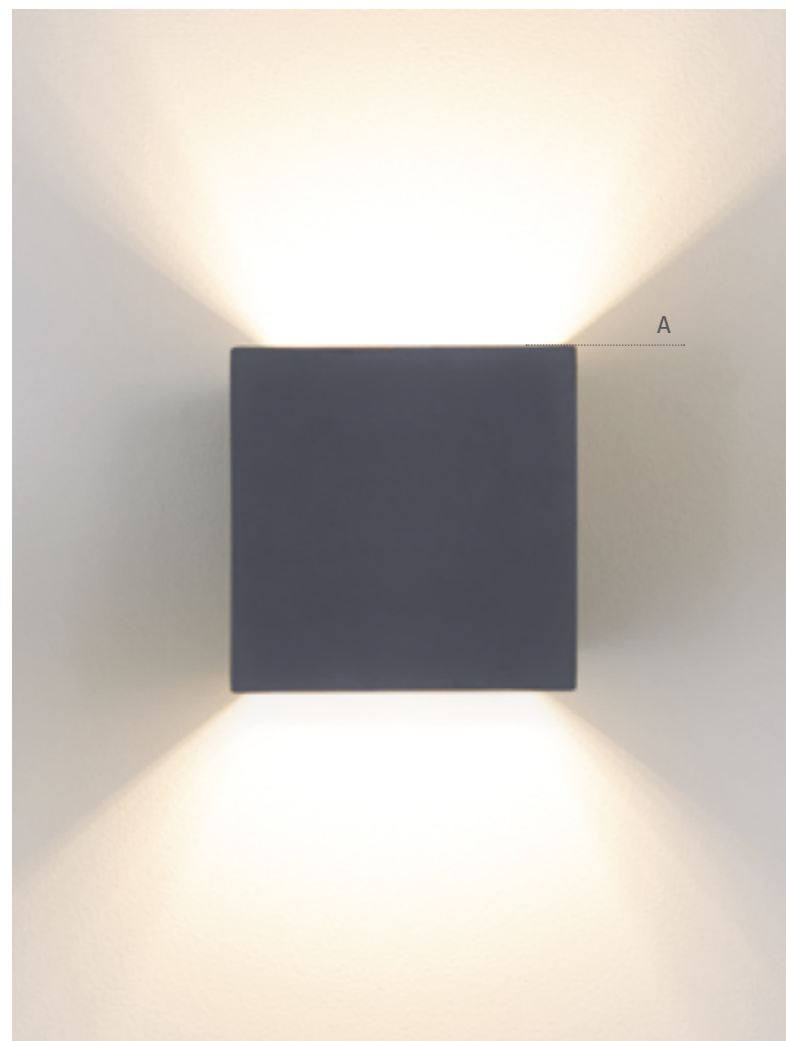

Codice articolo* / Article Code* **1092-396-3012**

Grado di protezione / Protection degree / Schutzart / Degré de protection **IP65**

Classe di isolamento / Insulation Class / Schutzklasse / Classe d'isolation **I**

Potenza / Power / Leistung / Puissance **LED 2x10W**

Tensione / Tension / Spannung / Tension **170-265V**

Tonalità / Colour temperature / Farbtemperatur / Température de couleur **3000°K**

Lumen **1600lm**

CRI **80**

Colori dei materiali* / Colors of the materials* / Farben der Materialien* / Couleurs des matériaux*
 392
 393
 394
 395
 396

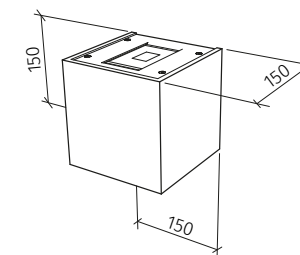

3,2 Kg

Alimentatore incluso / Power Supply included / Inklusive Betriebsgerät / Alimentation incluse

A: Piastra in acciaio inox satinato / Stainless satin steel Bracket / Halterung aus poliertem Edelstahl / Support en acier inoxydable satiné

Colori dei materiali / Colors of the materials
Farben der Materialien / Couleurs des matériaux



392
Bianco / White
Weiss / Blanc



393
Verde / Green
Grün / Vert



394
Corten



395
Grigio / Grey
Grau / Gris



396
Nero / Black
Schwarz / Noir

IT Misure espresse in mm, tolleranza +/- 1-2 mm. L'azienda si riserva la facoltà di apportare variazioni di dati caratteristici, materiali, design, stili, tonalità, senza alcun preavviso.

EN Measures in mm, tolerance +/- 1/2 mm. The company reserves the right to carry out variations to technical details, materials, design, style, colors with no previous notice.

DE Die Masse sind in mm, mit einer Toleranz von +/- 1-2 mm ausgedrückt, Die Firma behält sich das Recht vor ohne Voranmeldung Änderungen an den Werkstoffen, am Design, am Stil und an der Färbung vorzunehmen.

FR Mesures en mm, tolérance +/- 1/2 mm. La société se réserve le droit de modifier sans préavis les détails techniques, les matériaux, le design, le style et les couleurs.

1092-396-3012



Paletti / Bollard / Pollerleuchten / Bornes

CE BETALY® 9010 made in Italy

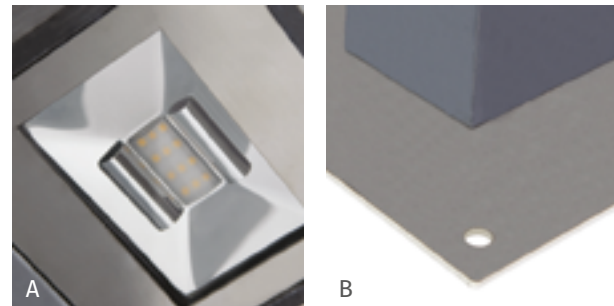
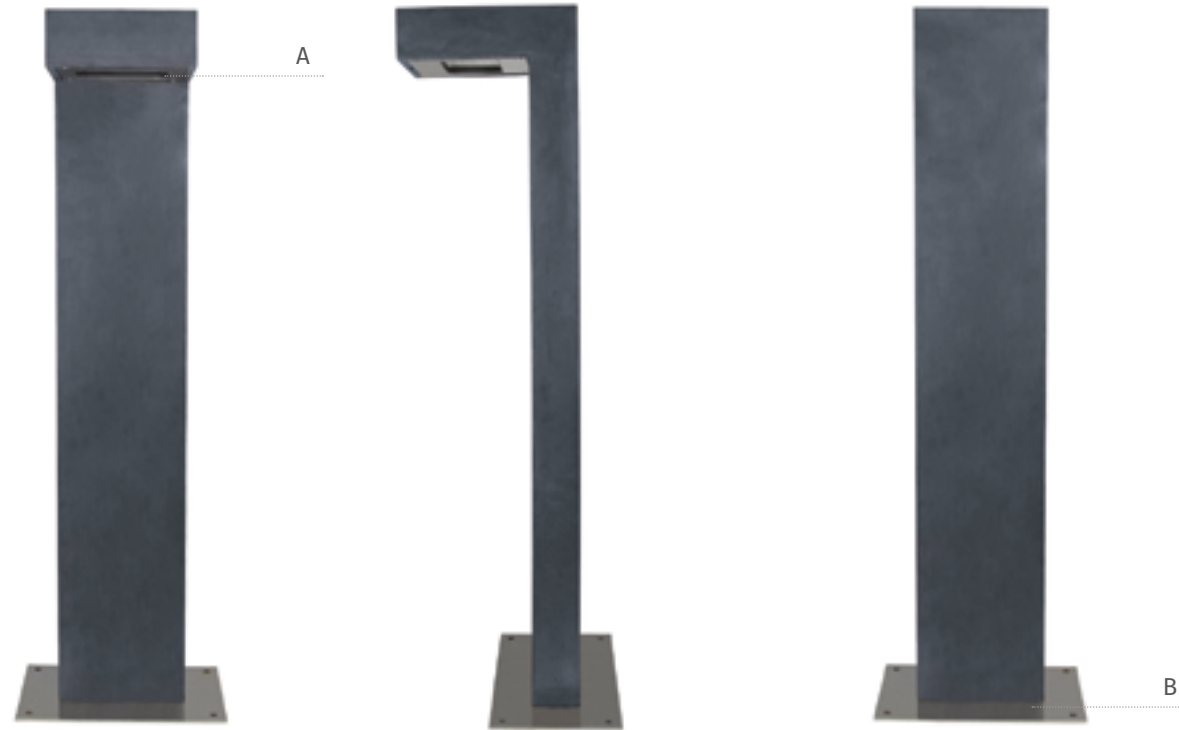
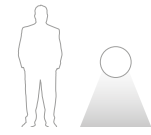

A: Piastra in acciaio inox satinato / Stainless satin steel Bracket / Halterung aus poliertem Edelstahl / Support en acier inoxydable satiné
B: Base in acciaio / Steel Base / Fuß aus Stahl / Base en acier

Codice articolo* / Article Code* **1093B-396-3011**
 Grado di protezione / Protection degree / Schutzart / Degré de protection **IP65**
 Classe di isolamento / Insulation Class / Schutzklasse / Classe d'isolation **I**
 Potenza / Power / Leistung / Puissance **LED 10W**
 Tensione / Tension / Spannung / Tension **170-265V**
 Tonalità / Colour temperature / Farbtemperatur / Température de couleur **3000°K**
 Lumen **750lm**
 CRI **80**
 Colori dei materiali* / Colors of the materials* / Farben der Materialien* / Couleurs des matériaux* **392 393 394 395 396**

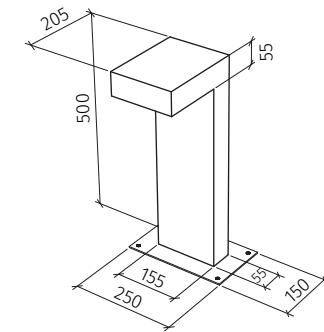

14,7 Kg

Alimentatore incluso / Power Supply included / Inklusive Betriebsgerät / Alimentation incluse

Codice articolo* / Article Code* **1093-396-3011**
 Grado di protezione / Protection degree / Schutzart / Degré de protection **IP65**
 Classe di isolamento / Insulation Class / Schutzklasse / Classe d'isolation **I**
 Potenza / Power / Leistung / Puissance **LED 10W**
 Tensione / Tension / Spannung / Tension **170-265V**
 Tonalità / Colour temperature / Farbtemperatur / Température de couleur **3000°K**
 Lumen **750lm**
 CRI **80**
 Colori dei materiali* / Colors of the materials* / Farben der Materialien* / Couleurs des matériaux* **392 393 394 395 396**

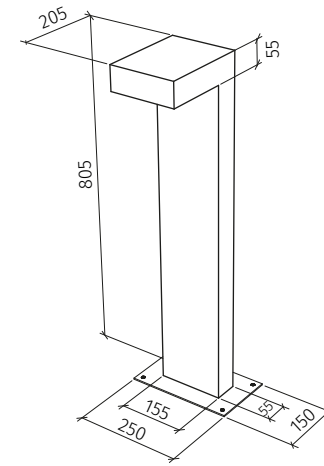

17,7 Kg

Alimentatore incluso / Power Supply included / Inklusive Betriebsgerät / Alimentation incluse

Colori dei materiali / Colors of the materials
Farben der Materialien / Couleurs des matériaux



392 Bianco / White / Weiss / Blanc
393 Verde / Green / Grün / Vert
394 Corten
395 Grigio / Grey / Grau / Gris
396 Nero / Black / Schwarz / Noir

IT Misure espresse in mm, tolleranza +/- 1-2 mm. L'azienda si riserva la facoltà di apportare variazioni di dati caratteristici, materiali, design, stili, tonalità, senza alcun preavviso.

EN Measures in mm, tolerance +/- 1/2 mm. The company reserves the right to carry out variations to technical details, materials, design, style, colors with no previous notice.

DE Die Masse sind in mm, mit einer Tolleranz von +/- 1-2 mm ausgedrückt, Die Firma behält sich das Recht vor ohne Voranmeldung Änderungen an den Werkstoffen, am Design, am Stil und an der Färbung vorzunehmen.

FR Mesures en mm, tolérance +/- 1/2 mm. La société se réserve le droit de modifier sans préavis les détails techniques, les matériaux, le design, le style et les couleurs.

1093-396-3011



1093B-395-3011 / 1093B-394-3011



A plafone / Ceiling lighting / Deckenleuchten / Plafonniers



BETALY®
9010

made in Italy



Codice articolo* / Article Code* **1094-396-3012**

Grado di protezione / Protection degree **IP65**
Schutzart / Degré de protection

Classe di isolamento / Insulation Class **I**
Schutzklasse / Classe d'isolation

Potenza / Power **LED 10W**
Leistung / Puissance

Tensione / Tension **170-265V**
Spannung / Tension

Tonalità / Colour temperature **3000°K**
Farbtemperatur / Température de couleur

Lumen **800lm**

CRI **80**

Colori dei materiali* / Colors of the materials*
Farben der Materialien* / Couleurs des matériaux*

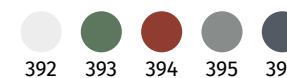

3,2 Kg

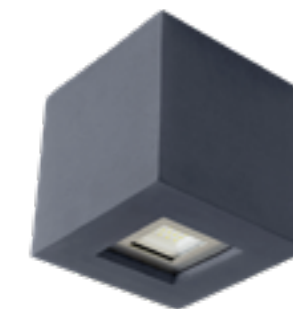
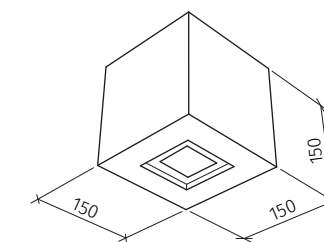

Alimentatore incluso / Power Supply included / Inklusive Betriebsgerät / Alimentation incluse

Colori dei materiali / Colors of the materials
Farben der Materialien / Couleurs des matériaux



392
Bianco / White
Weiss / Blanc



393
Verde / Green
Grün / Vert



394
Corten



395
Grigio / Grey
Grau / Gris



396
Nero / Black
Schwarz / Noir

IT Misure espresse in mm, tolleranza +/- 1-2 mm. L'azienda si riserva la facoltà di apportare variazioni di dati caratteristici, materiali, design, stili, tonalità, senza alcun preavviso.

EN Measures in mm, tolerance +/- 1/2 mm. The company reserves the right to carry out variations to technical details, materials, design, style, colors with no previous notice.

DE Die Masse sind in mm, mit einer Tolleranz von +/- 1-2 mm ausgedrückt, Die Firma behält sich das Recht vor ohne Voranmeldung Änderungen an den Werkstoffen, am Design, am Stil und an der Färbung vorzunehmen.

FR Mesures en mm, tolérance +/- 1/2 mm. La société se réserve le droit de modifier sans préavis les détails techniques, les matériaux, le design, le style et les couleurs.

1094-396-3012



1094-396-3012

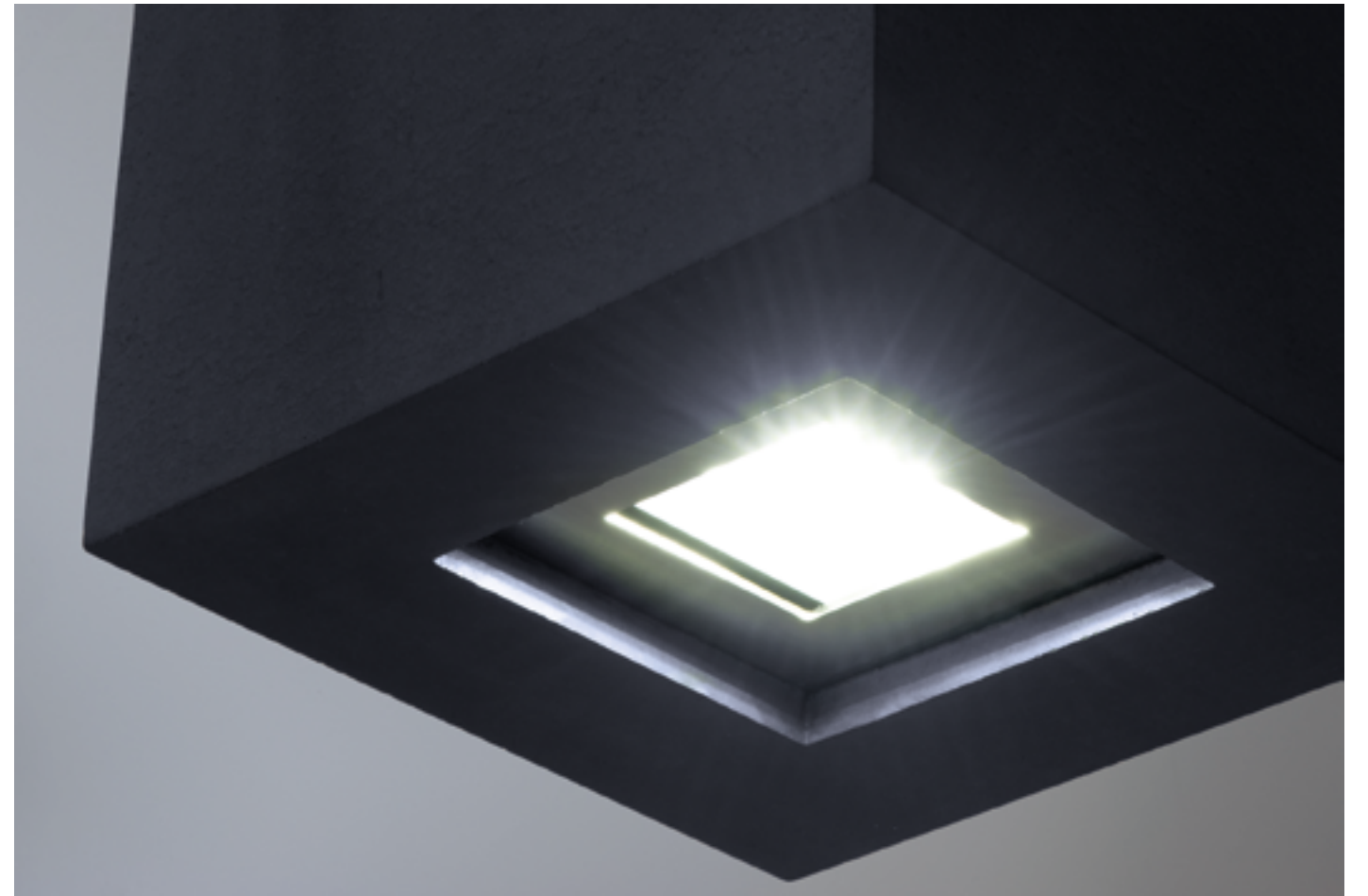

A parete / Wall lighting / Wandleuchten / Appliques



BETALY®
9010

made in Italy



Codice articolo* / Article Code* **1095B-396-30160**

Grado di protezione / Protection degree **IP65**
Schutzart / Degré de protection

Classe di isolamento / Insulation Class **III**
Schutzklasse / Classe d'isolation

Potenza / Power **LED 6W**
Leistung / Puissance

Tensione / Tension **** 24Vdc**
Spannung / Tension

Tonalità / Colour temperature **3000°K**
Farbtemperatur / Température de couleur

Lumen **800lm**

CRI **80**

Colori dei materiali* / Colors of the materials*
Farben der Materialien* / Couleurs des matériaux*

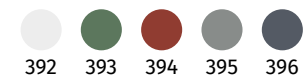

1,9 Kg

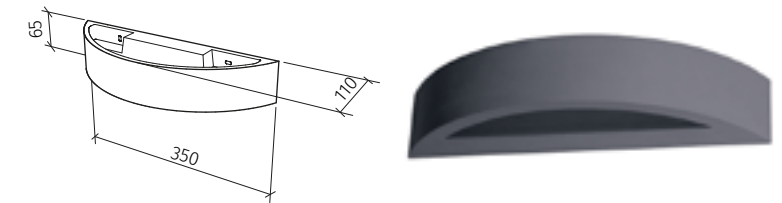

Alimentatore da ordinare separatamente / Power Supply to be ordered separately / Betriebsgerät separate zu bestellen / Alimentation à commander séparément

** Necessita di alimentatore remoto tensione costante / Remote constant voltage driver is required
Benötigt externe Spannungsversorgung / Alimentateur à tension constante déporté nécessaire

Colori dei materiali / Colors of the materials
Farben der Materialien / Couleurs des matériaux



392
Bianco / White
Weiss / Blanc

393
Verde / Green
Grün / Vert

394
Corten

395
Grigio / Grey
Grau / Gris

396
Nero / Black
Schwarz / Noir

026.258



12W - 24Vdc
IP20
130x42x23mm
ON/OFF
IN 220-240V-

026.259



36W - 24Vdc
IP20
167x45x30mm
ON/OFF
IN 220-240V-

026.301



24W - 24Vdc
IP20
164x38x25mm
DIM PUSH / DALI / 0-10V / 1-10V
IN 220-240V-

IT Misure espresse in mm, tolleranza +/- 1-2 mm. L'azienda si riserva la facoltà di apportare variazioni di dati caratteristici, materiali, design, stili, tonalità, senza alcun preavviso.

EN Measures in mm, tolerance +/- 1/2 mm. The company reserves the right to carry out variations to technical details, materials, design, style, colors with no previous notice.

DE Die Masse sind in mm, mit einer Tolleranz von +/- 1-2 mm ausgedrückt, Die Firma behält sich das Recht vor ohne Voranmeldung Änderungen an den Werkstoffen, am Design, am Stil und an der Färbung vorzunehmen.

FR Mesures en mm, tolérance +/- 1/2 mm. La société se réserve le droit de modifier sans préavis les détails techniques, les matériaux, le design, le style et les couleurs.

1095B-393-30160



1095B-393-30160

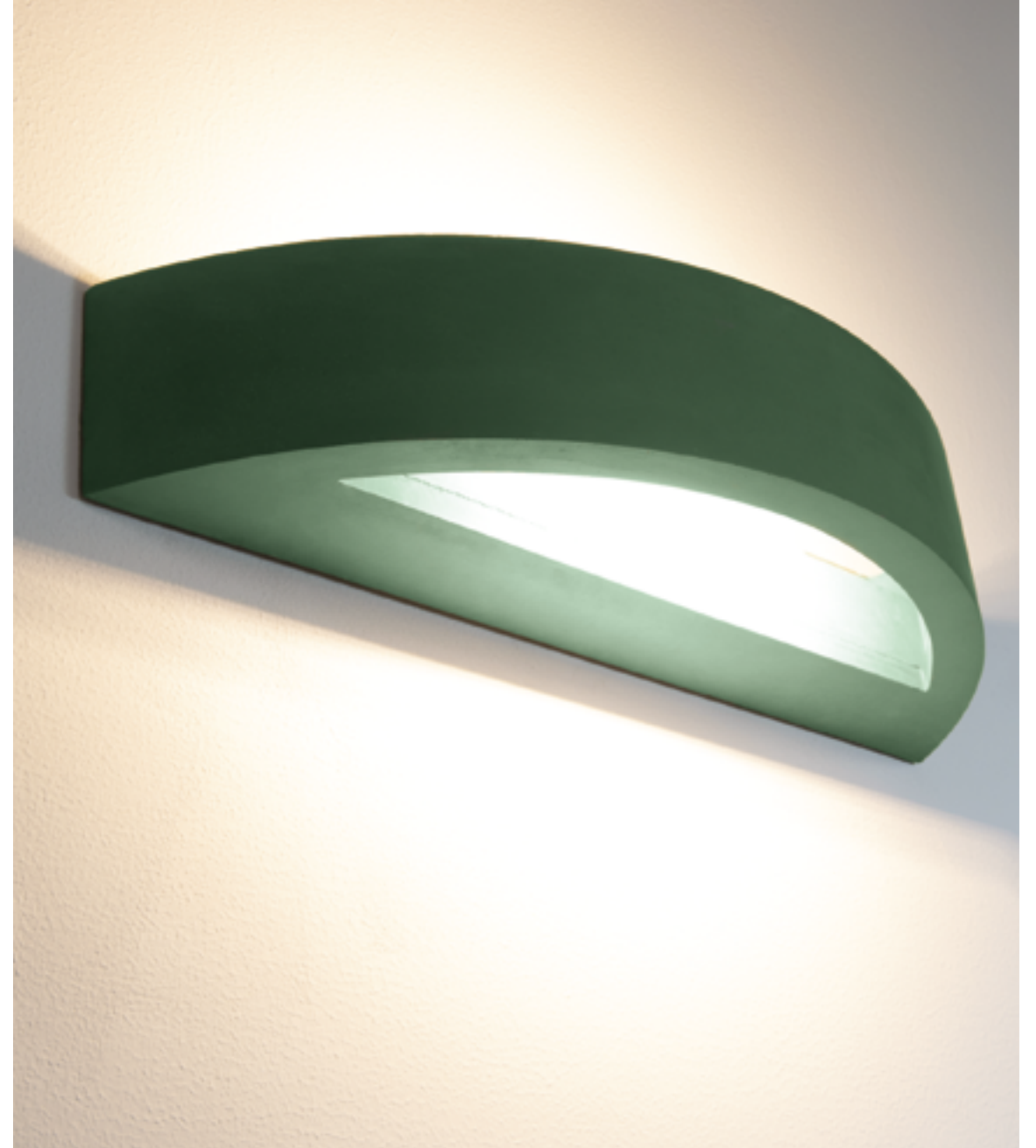

A parete / Wall lighting / Wandleuchten / Appliques

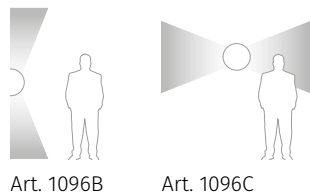

Art. 1096B

Art. 1096C

Art. 1096B

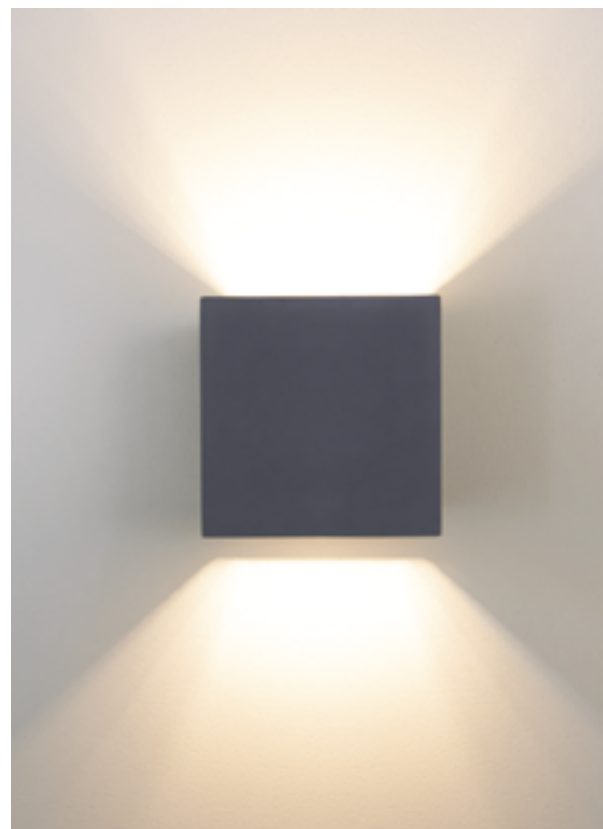

Art. 1096C



BETALY®
9010

made in Italy

Codice articolo* / Article Code* **1096B-396-30160**

Grado di protezione / Protection degree / Schutzart / Degré de protection **IP65**

Classe di isolamento / Insulation Class / Schutzklasse / Classe d'isolation **III**

Potenza / Power / Leistung / Puissance **LED 6W**

Tensione / Tension / Spannung / Tension **** 24Vdc**

Tonalità / Colour temperature / Farbtemperatur / Température de couleur **3000°K**

Lumen **800lm**

CRI **80**

Colori dei materiali* / Colors of the materials* / Farben der Materialien* / Couleurs des matériaux*

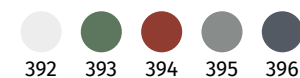

1,5 Kg

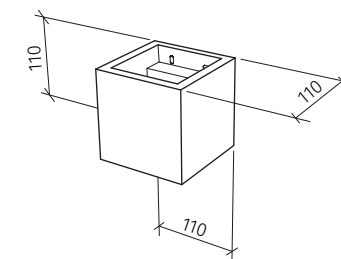

Alimentatore da ordinare separatamente / Power Supply to be ordered separately / Betriebsgerät separate zu bestellen / Alimentation à commander séparément

Codice articolo* / Article Code* **1096C-396-30160**

Grado di protezione / Protection degree / Schutzart / Degré de protection **IP65**

Classe di isolamento / Insulation Class / Schutzklasse / Classe d'isolation **III**

Potenza / Power / Leistung / Puissance **LED 6W**

Tensione / Tension / Spannung / Tension **** 24Vdc**

Tonalità / Colour temperature / Farbtemperatur / Température de couleur **3000°K**

Lumen **800lm**

CRI **80**

Colori dei materiali* / Colors of the materials* / Farben der Materialien* / Couleurs des matériaux*

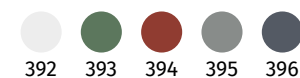

1,5 Kg

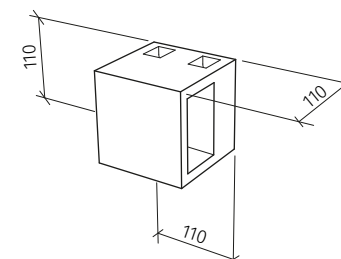

Alimentatore da ordinare separatamente / Power Supply to be ordered separately / Betriebsgerät separate zu bestellen / Alimentation à commander séparément

** Necessita di alimentatore remoto tensione costante / Remote constant voltage driver is required
Benötigt externe Spannungsversorgung / Alimentateur à tension constante déporté nécessaire

Colori dei materiali / Colors of the materials
Farben der Materialien / Couleurs des matériaux



392
Bianco / White
Weiss / Blanc



393
Verde / Green
Grün / Vert



394
Corten



395
Grigio / Grey
Grau / Gris



396
Nero / Black
Schwarz / Noir

026.258



12W - 24Vdc
IP20
130x42x23mm
ON/OFF
IN 220-240V-

026.259



36W - 24Vdc
IP20
167x45x30mm
ON/OFF
IN 220-240V-

026.301



24W - 24Vdc
IP20
164x38x25mm
DIM PUSH / DALI / 0-10V / 1-10V
IN 220-240V-

IT Misure espresse in mm, tolleranza +/- 1-2 mm. L'azienda si riserva la facoltà di apportare variazioni di dati caratteristici, materiali, design, stili, tonalità, senza alcun preavviso.

EN Measures in mm, tolerance +/- 1/2 mm. The company reserves the right to carry out variations to technical details, materials, design, style, colors with no previous notice.

DE Die Masse sind in mm, mit einer Tolleranz von +/- 1-2 mm ausgedrückt, Die Firma behält sich das Recht vor ohne Voranmeldung Änderungen an den Werkstoffen, am Design, am Stil und an der Färbung vorzunehmen.

FR Mesures en mm, tolérance +/- 1/2 mm. La société se réserve le droit de modifier sans préavis les détails techniques, les matériaux, le design, le style et les couleurs.

1096B-395-30160



1096C-395-30160



A parete / Wall lighting / Wandleuchten / Appliques

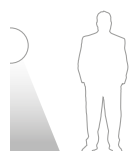

BETALY®
9010

made in Italy

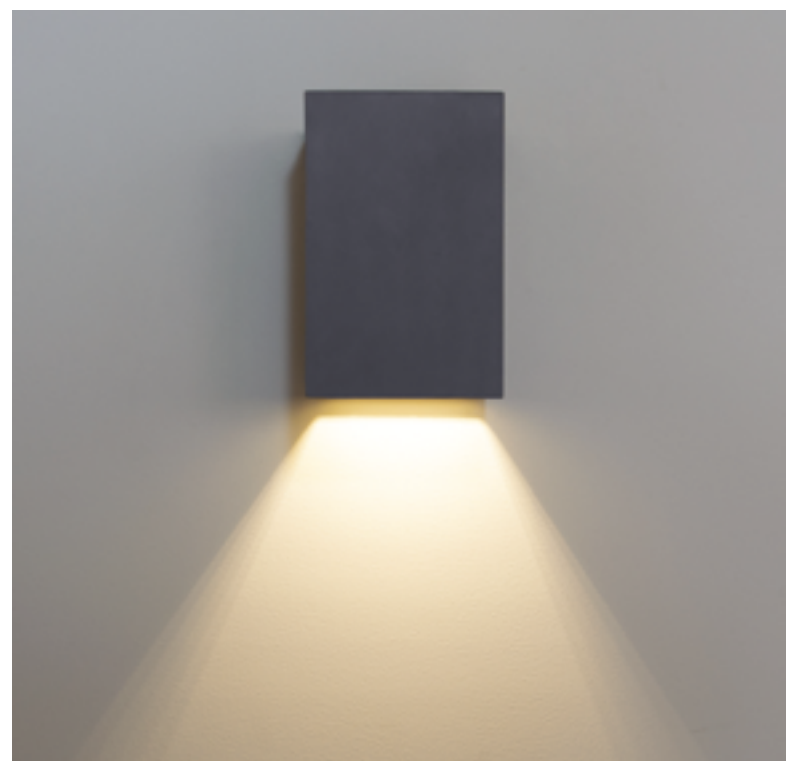

Codice articolo* / Article Code* **1097-396-30159**

Grado di protezione / Protection degree **IP65**
Schutzart / Degré de protection

Classe di isolamento / Insulation Class **I**
Schutzklasse / Classe d'isolation

Potenza / Power **LED 10W**
Leistung / Puissance

Tensione / Tension **220-240V**
Spannung / Tension

Tonalità / Colour temperature **3000°K**
Farbtemperatur / Température de couleur

Lumen **800lm**

CRI **80**

Colori dei materiali* / Colors of the materials*
Farben der Materialien* / Couleurs des matériaux*

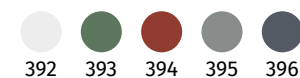

3,5 Kg

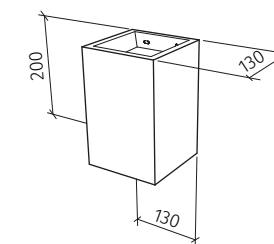

Alimentatore incluso / Power Supply included / Inklusive Betriebsgerät / Alimentation incluse

Colori dei materiali / Colors of the materials
Farben der Materialien / Couleurs des matériaux



392
Bianco / White
Weiss / Blanc



393
Verde / Green
Grün / Vert



394
Corten



395
Grigio / Grey
Grau / Gris



396
Nero / Black
Schwarz / Noir

IT Misure espresse in mm, tolleranza +/- 1-2 mm. L'azienda si riserva la facoltà di apportare variazioni di dati caratteristici, materiali, design, stili, tonalità, senza alcun preavviso.

EN Measures in mm, tolerance +/- 1/2 mm. The company reserves the right to carry out variations to technical details, materials, design, style, colors with no previous notice.

DE Die Masse sind in mm, mit einer Tolleranz von +/- 1-2 mm ausgedrückt, Die Firma behält sich das Recht vor ohne Voranmeldung Änderungen an den Werkstoffen, am Design, am Stil und an der Färbung vorzunehmen.

FR Mesures en mm, tolérance +/- 1/2 mm. La société se réserve le droit de modifier sans préavis les détails techniques, les matériaux, le design, le style et les couleurs.

1097-394-3012



1097-394-3012



Paletti e segnapassi / Bollard and pathmarkers /
Pollerleuchten und orientierungsbeleuchtung / Bornes et balisages



BETALY®
9010

made in Italy

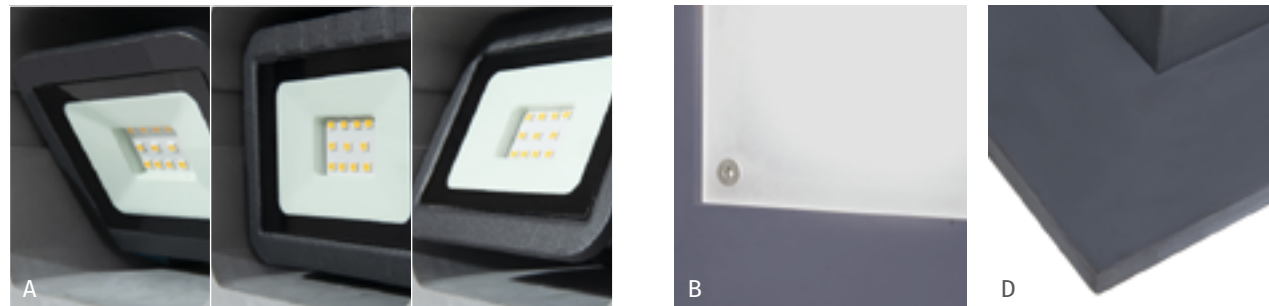
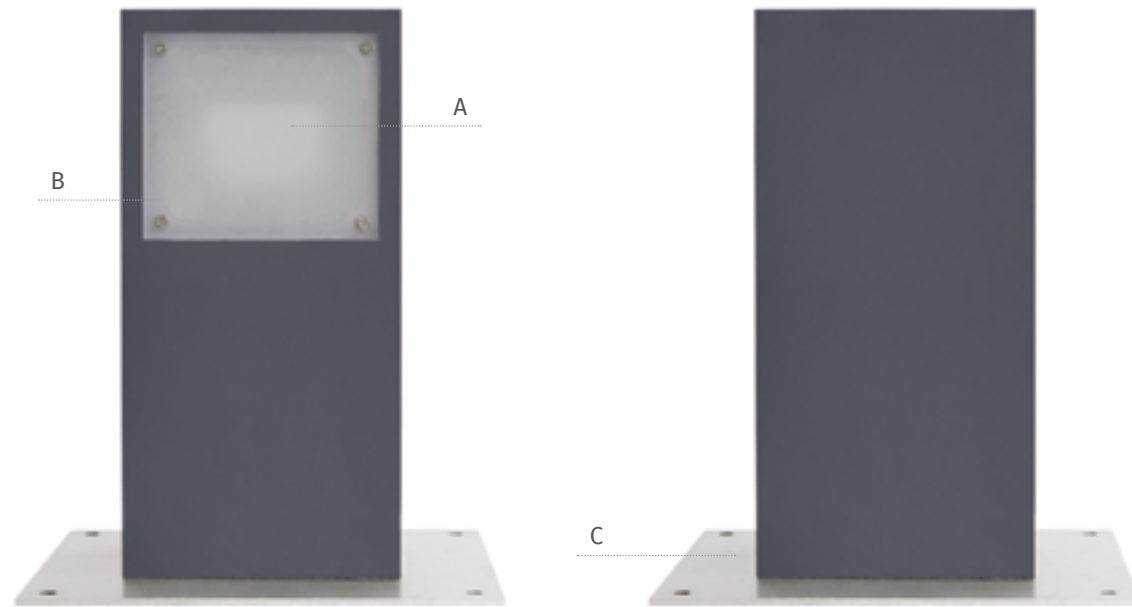
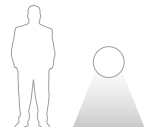

A: Faretto orientabile / Tilttable Light / Schwenkbare Leuchte / Lampe orientable

B: Vetro temperato acidato / Tempered etched glass / Geätztes gehärtetes Glas / Verre trempé satiné

C: Base in acciaio / Steel Base / Fuß aus Stahl / Base en acier

D: Copri base in BETALY® (p. 148) / Cover-base in BETALY® (p. 148) / Sockel aus BETALY® (p. 148) / Couverture de la base en BETALY® (p. 148)

Colori dei materiali / Colors of the materials
Farben der Materialien / Couleurs des matériaux



392
Bianco / White
Weiss / Blanc

393
Verde / Green
Grün / Vert

394
Corten

395
Grigio / Grey
Grau / Gris

396
Nero / Black
Schwarz / Noir

Codice articolo* / Article Code* **1111A-396-3012**

Grado di protezione / Protection degree / Schutzart / Degré de protection **IP65**

Classe di isolamento / Insulation Class / Schutzklasse / Classe d'isolation **I**

Potenza / Power / Leistung / Puissance **LED 10W**

Tensione / Tension / Spannung / Tension **170-265V**

Tonalità / Colour temperature / Farbtemperatur / Température de couleur **3000°K**

Lumen **800lm**

CRI **80**

Colori dei materiali* / Colors of the materials* / Farben der Materialien* / Couleurs des matériaux* **392 393 394 395 396**

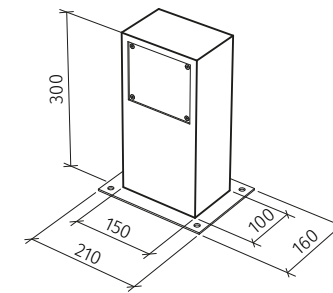

8,5 Kg

Alimentatore incluso / Power Supply included / Inklusive Betriebsgerät / Alimentation incluse

Codice articolo* / Article Code* **1111B-396-3012**

Grado di protezione / Protection degree / Schutzart / Degré de protection **IP65**

Classe di isolamento / Insulation Class / Schutzklasse / Classe d'isolation **I**

Potenza / Power / Leistung / Puissance **LED 10W**

Tensione / Tension / Spannung / Tension **170-265V**

Tonalità / Colour temperature / Farbtemperatur / Température de couleur **3000°K**

Lumen **800lm**

CRI **80**

Colori dei materiali* / Colors of the materials* / Farben der Materialien* / Couleurs des matériaux* **392 393 394 395 396**

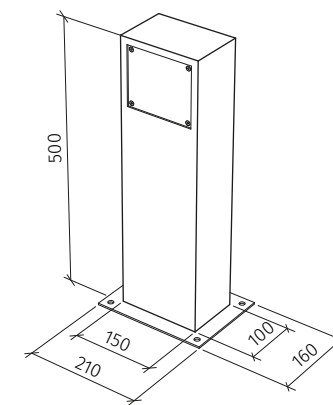

15 Kg

Alimentatore incluso / Power Supply included / Inklusive Betriebsgerät / Alimentation incluse

IT Misure espresse in mm, tolleranza +/- 1-2 mm. L'azienda si riserva la facoltà di apportare variazioni di dati caratteristici, materiali, design, stili, tonalità, senza alcun preavviso.

EN Measures in mm, tolerance +/- 1/2 mm. The company reserves the right to carry out variations to technical details, materials, design, style, colors with no previous notice.

DE Die Masse sind in mm, mit einer Tolleranz von +/- 1-2 mm ausgedrückt, Die Firma behält sich das Recht vor ohne Voranmeldung Änderungen an den Werkstoffen, am Design, am Stil und an der Färbung vorzunehmen.

FR Mesures en mm, tolérance +/- 1/2 mm. La société se réserve le droit de modifier sans préavis les détails techniques, les matériaux, le design, le style et les couleurs.

1111A-393-3012 / 1111A-395-3012



1111A-395-3012



Numeri civici / House numbers
Hausnummern / Numéros de maison



Codice articolo*
Article Code* **N0-396**

Colori dei materiali* / Colors of the materials*
Farben der Materialien* / Couleurs des matériaux*

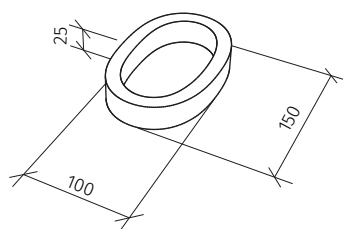

Codice articolo*
Article Code* **N5-396**

Colori dei materiali* / Colors of the materials*
Farben der Materialien* / Couleurs des matériaux*

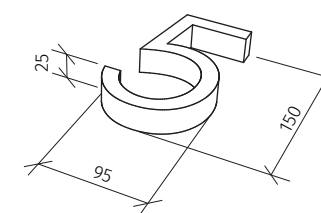
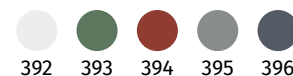

Codice articolo*
Article Code* **N1-396**

Colori dei materiali* / Colors of the materials*
Farben der Materialien* / Couleurs des matériaux*

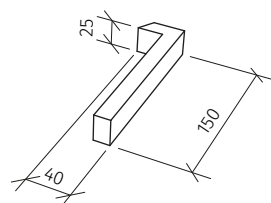

Codice articolo*
Article Code* **N6-396**

Colori dei materiali* / Colors of the materials*
Farben der Materialien* / Couleurs des matériaux*

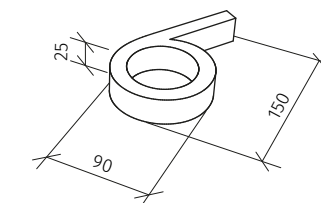
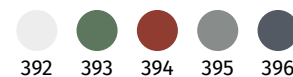

Codice articolo*
Article Code* **N2-396**

Colori dei materiali* / Colors of the materials*
Farben der Materialien* / Couleurs des matériaux*

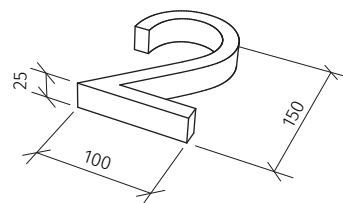

Codice articolo*
Article Code* **N7-396**

Colori dei materiali* / Colors of the materials*
Farben der Materialien* / Couleurs des matériaux*

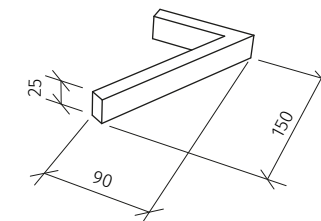

Codice articolo*
Article Code* **N3-396**

Colori dei materiali* / Colors of the materials*
Farben der Materialien* / Couleurs des matériaux*

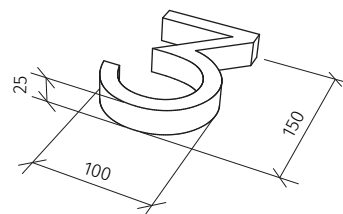

Codice articolo*
Article Code* **N8-396**

Colori dei materiali* / Colors of the materials*
Farben der Materialien* / Couleurs des matériaux*

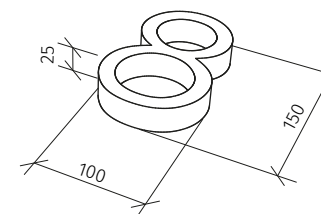
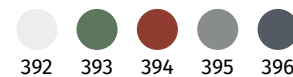

Codice articolo*
Article Code* **N4-396**

Colori dei materiali* / Colors of the materials*
Farben der Materialien* / Couleurs des matériaux*

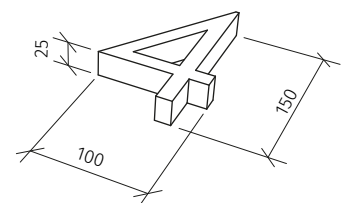

Codice articolo*
Article Code* **N9-396**

Colori dei materiali* / Colors of the materials*
Farben der Materialien* / Couleurs des matériaux*

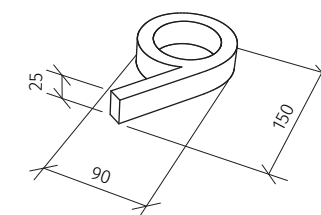
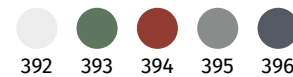

IT Misure espresse in mm, tolleranza +/- 1-2 mm. L'azienda si riserva la facoltà di apportare variazioni di dati caratteristici, materiali, design, stili, tonalità, senza alcun preavviso.

EN Measures in mm, tolerance +/- 1/2 mm. The company reserves the right to carry out variations to technical details, materials, design, style, colors with no previous notice.

DE Die Masse sind in mm, mit einer Tolleranz von +/- 1-2 mm ausgedrückt, Die Firma behält sich das Recht vor ohne Voranmeldung Änderungen an den Werkstoffen, am Design, am Stil und an der Färbung vorzunehmen.

FR Mesures en mm, tolérance +/- 1/2 mm. La société se réserve le droit de modifier sans préavis les détails techniques, les matériaux, le design, le style et les couleurs.

N2-395 + N4-395



Copri base per 1103A - 1103B

Cover-base in BETALY® / Sockel aus BETALY® / Couverture de la base en BETALY®

Codice articolo* **1103K-396***
Article Code*

Colori dei materiali* / Colors of the materials*
Farben der Materialien* / Couleurs des matériaux*

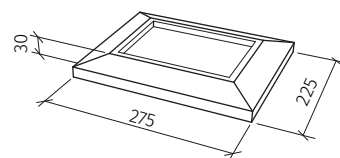
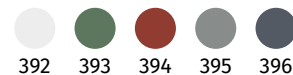

Copri base per 1110A - 1110B

Cover-base in BETALY® / Sockel aus BETALY® / Couverture de la base en BETALY®

Codice articolo* **1110K-396***
Article Code*

Colori dei materiali* / Colors of the materials*
Farben der Materialien* / Couleurs des matériaux*

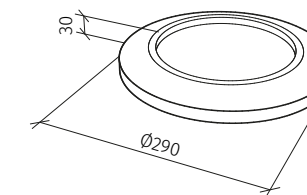
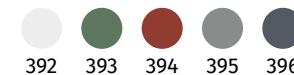

Copri base per 1105B - 1105C

Cover-base in BETALY® / Sockel aus BETALY® / Couverture de la base en BETALY®

Codice articolo* **1105K-396***
Article Code*

Colori dei materiali* / Colors of the materials*
Farben der Materialien* / Couleurs des matériaux*

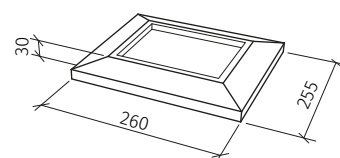
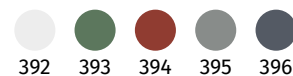

Copri base per 1111A - 1111B

Cover-base in BETALY® / Sockel aus BETALY® / Couverture de la base en BETALY®

Codice articolo* **1111K-396***
Article Code*

Colori dei materiali* / Colors of the materials*
Farben der Materialien* / Couleurs des matériaux*

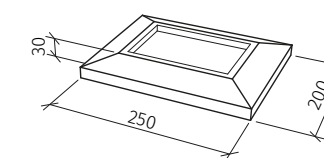
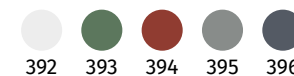

Copri base per 1106A

Cover-base in BETALY® / Sockel aus BETALY® / Couverture de la base en BETALY®

Codice articolo* **1106K-396***
Article Code*

Colori dei materiali* / Colors of the materials*
Farben der Materialien* / Couleurs des matériaux*

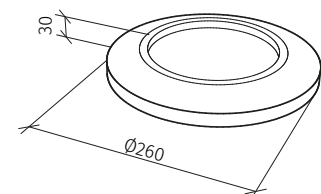
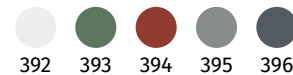

IT Misure espresse in mm, tolleranza +/- 1-2 mm. L'azienda si riserva la facoltà di apportare variazioni di dati caratteristici, materiali, design, stili, tonalità, senza alcun preavviso.

EN Measures in mm, tolerance +/- 1/2 mm. The company reserves the right to carry out variations to technical details, materials, design, style, colors with no previous notice.

DE Die Masse sind in mm, mit einer Tolleranz von +/- 1-2 mm ausgedrückt, Die Firma behält sich das Recht vor ohne Voranmeldung Änderungen an den Werkstoffen, am Design, am Stil und an der Färbung vorzunehmen.

FR Mesures en mm, tolérance +/- 1/2 mm. La société se réserve le droit de modifier sans préavis les détails techniques, les matériaux, le design, le style et les couleurs.

1103B-395-3012 + 1103K-395



1103B-395-3012 + 1103K-395

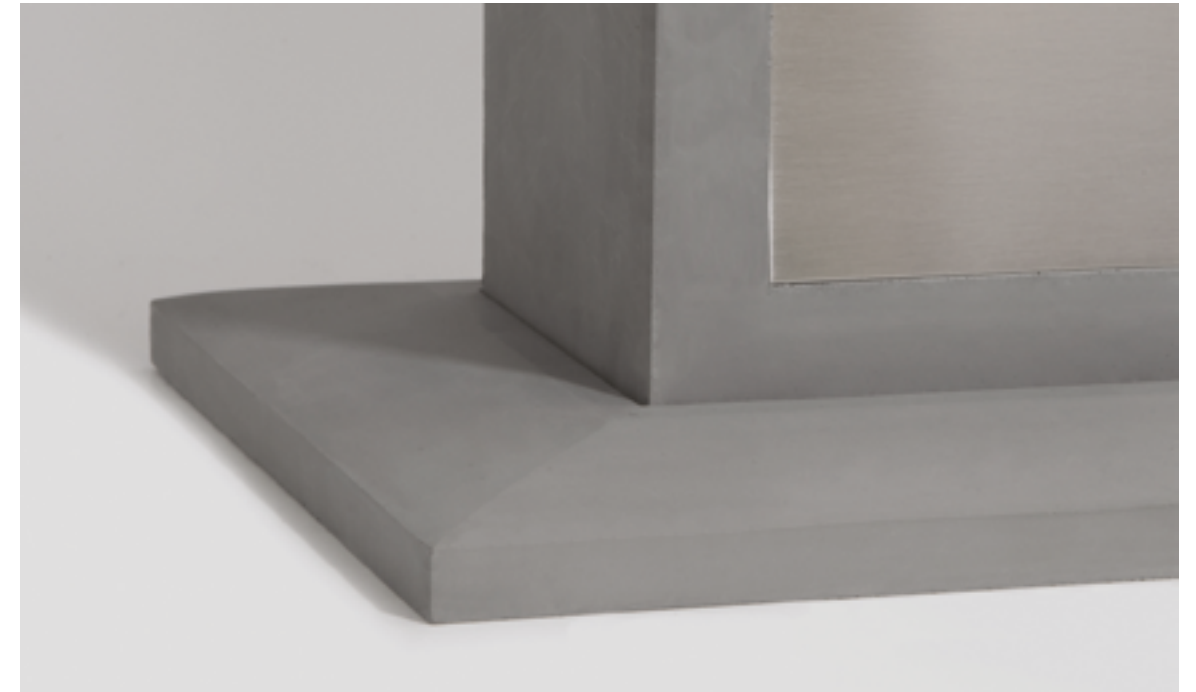

Indice analitico / Analytical Index
Analytischer Index / Index analytique

1090	p. 102	1106A	p. 82
1091	p. 106	1106K	p. 148
1091B	p. 110	1106Q	p. 82
1091C	p. 110	1107	p. 24
1092	p. 114	1108A	p. 60
1093	p. 118	1108B	p. 60
1093B	p. 118	1109	p. 50
1094	p. 122	1110A	p. 92
1095B	p. 126	1110B	p. 92
1096B	p. 130	1110K	p. 148
1096C	p. 130	1111A	p. 138
1097	p. 134	1111B	p. 138
1098	p. 96	1111K	p. 148
1102	p. 40	N0	p. 144
1103A	p. 34	N1	p. 144
1103B	p. 30	N2	p. 144
1103K	p. 148	N3	p. 144
1104A	p. 76	N4	p. 144
1104Q	p. 76	N5	p. 144
1105A	p. 70	N6	p. 144
1105B	p. 70	N7	p. 144
1105C	p. 70	N8	p. 144
1105K	p. 148	N9	p. 144

INFORMAZIONI DI CARATTERE GENERALE

Tutti i prodotti 9010, fatto salvo i prodotti con LED incluso, sono forniti senza lampadina.

La garanzia dei prodotti 9010 con LED decade con utilizzo di alimentatori non forniti da 9010 e/o in caso di inosservanza delle istruzioni di collegamento.

Le etichette energetiche sono disponibili su richiesta o scaricabili dal sito www.9010.it.

I cataloghi e la documentazione tecnica completa e aggiornata sono disponibili su richiesta o scaricabili dal sito www.9010.it.

I dati fotometrici sono disponibili su richiesta o scaricabili dal sito www.9010.it

Tutti i prodotti sono conformi alle direttive CE. Valutazioni tecniche sulle certificazioni di sicurezza sono disponibili su richiesta.

Rivolgersi a personale qualificato per il collegamento.

Eventuali efflorescenze sono normali, dato le caratteristiche naturali del prodotto. Le efflorescenze sono una decolorazione causata da depositi cristallini di sali sulle superfici in calcestruzzo.

BETALY® è un materiale realizzato artigianalmente. Pertanto sono possibili variazioni estetiche nei colori, che non pregiudicano la qualità del prodotto.

I Marchi 9010®, ALUMITE 9010® e BETALY 9010® sono di proprietà di Belfiore Srl.

GENERAL INFORMATION

All 9010 products are delivered without bulb, except for products having LED included.

The warranty of 9010 LED products is not applicable in case of connection with Power Supplies that are not delivered by 9010 and/or in case of failure/non conformity with the mounting/connection instructions.

Energy Labels are available on demand or downloadable at www.9010.it.

Our update catalogues and technical documents are available on demand or downloadable at www.9010.it.

Photometric Data are available on demand or downloadable at www.9010.it.

All our products comply with CE Directives. Technical evaluations on safety certifications are available on demand.

Always contact qualified personnel for the wire connection.

Any efflorescence is normal, given the natural characteristics of the product. Efflorescence is a discoloration caused by crystalline salt deposits on concrete surfaces.

BETALY® is a handmade material. Aesthetic variations in the colours may occur and does not affect the quality of the product.

The brands 9010®, ALUMITE 9010® and BETALY 9010® are registered trademarks of Belfiore Srl.

ALLGEMEINE INFORMATIONEN

Alle Produkte 9010, mit Ausnahme jener inklusive LED, werden mit Lampenfassung aber ohne Lampe geliefert.

Die Garantie der Produkte 9010 mit LED verfällt, wenn sie nicht mit den für die Artikel 9010 gelieferten Betriebsgeräte verwendet bzw. die Anleitungen für den Anschluss missachtet werden.

Die Energieetiketten sind auf Anfrage verfügbar oder können von der Webseite www.9010.it heruntergeladen werden.

Die aktualisierte Kataloge und technischen Unterlagen sind auf Anfrage verfügbar oder können von der Webseite www.9010.it heruntergeladen werden.

Die fotometrischen Daten sind auf Anfrage verfügbar oder können von der Webseite www.9010.it heruntergeladen werden.

Alle Produkte entsprechen den EG-Richtlinien. Technische Bewertungen der Sicherheitszertifikate sind auf Anfrage verfügbar. Wenden Sie sich für den Anschluss an qualifiziertes Personal.

Aufgrund der natürlichen Eigenschaften des Produkts können Ausblühungen auftreten, die als normale Erscheinung zu betrachten sind. Ausblühungen sind eine Dekolorierung, die durch kristalline Salzablagerungen auf Betonoberflächen entsteht.

BETALY® ist ein handverarbeitetes Material. Es können ästhetische Farbabweichungen auftreten, die die Qualität des Produktes nicht beeinflussen.

Die Marken 9010®, ALUMITE 9010® und BETALY 9010® sind Eigentum der Belfiore Srl.

INFORMATIONS À CARACTÈRE GÉNÉRAL

Tous les produits 9010, à l'exception des produits avec LED incluse, sont fournis sans ampoule.

La garantie des produits 9010 à LED expire en cas d'utilisation d'alimentations non fournies par 9010 ou en cas de non-respect des instructions de raccordement.

Les étiquettes-énergie sont disponibles sur demande ou peuvent être téléchargées depuis le site www.9010.it

Les catalogues et la documentation technique actualisées sont disponibles sur demande ou peuvent être téléchargés depuis le site www.9010.it.

Les données photométriques sont disponibles sur demande ou peuvent être téléchargées depuis le site www.9010.it

Tous les produits sont conformes aux directives CE. Les évaluations techniques sur les certifications de sécurité sont disponibles sur demande.

S'adresser à un personnel qualifié pour le raccordement.

Comme il s'agit d'un produit naturel, la présence éventuelle d'efflorescences est normale. Les efflorescences sont une décoloration causée par des dépôts de cristaux de sels sur les surfaces en ciment.

BETALY® est un matériau réalisé artisanalement. Donc des variations esthétiques dans les couleurs sont possible, qui n'affectent pas la qualité du produit

Les marques 9010®, ALUMITE 9010® et BETALY 9010® appartiennent à Belfiore Srl.

Il presente catalogo non può essere riprodotto neppure parzialmente. Tutti i diritti sono riservati.

Le fotografie, la descrizione degli apparecchi, le quote, le dimensioni ed i valori fotometrici menzionati in questo catalogo sono a titolo indicativo e non costituiscono alcun impegno per la nostra società, che si riserva di apportare, senza preavviso, tutte le modifiche che riterrà opportune. I dati tecnici presenti in questo catalogo sono aggiornati alla data di stampa (MARZO 2020).

Consultare le schede tecniche e le istruzioni di montaggio presenti sul sito web per avere i dati tecnici aggiornati.

I prodotti presenti in questo catalogo sono MODELLI REGISTRATI.

EN *This catalogue must not be wholly or partially reproduced. All rights reserved.*

Photographs, descriptions of appliances, technical data, measurements and photometric values given in this catalogue are indicative and do not entail any obligation on our firm, which reserves the right to make any changes it considers appropriate, without prior warning.

Technical data given in this catalogue are current at the time of printing (MARCH 2020).

Please consult the technical specifications and assembly instruction on our website for updates on technical data.

Products included in this catalogue are REGISTERED MODELS.

DE *Der vorliegende Katalog darf weder ganz noch teilweise reproduziert werden. Alle Rechte sind vorbehalten.*

Die in diesem Katalog genannten Fotografien, die Beschreibung der Geräte, die Maße, die Abmessungen und photometrischen Werte sind rein indikativ und stellen keine Verpflichtung für unser Unternehmen dar, das sich das Recht vorbehält, alle für angemessen erachtete Änderungen ohne vorherige Ankündigungen vorzunehmen.

Die technischen Daten in diesem Katalog wurden zum Zeitpunkt des Drucks (MÄRZ 2020) aktualisiert. Aktuelle technische Daten finden Sie in den technischen Datenblättern und Montageanleitungen auf der Webseite.

Die in diesem Katalog enthaltenen Produkte sind REGISTRIERT.

FR *Toute reproduction, en tout ou partie, de ce catalogue est interdite. Tous droits réservés.*

Les photographies, la description des appareils, les cotes, les dimensions et les valeurs photométriques indiquées dans ce catalogue sont indicatives et ne sont en aucun cas contraignantes pour notre société, qui se réserve le droit d'apporter, sans préavis, toutes les modifications qu'elle jugera opportunes.

Les caractéristiques techniques figurant dans ce catalogue sont à jour à la date d'impression (MARS 2020).

Consulter les fiches techniques et les instructions de montage disponibles sur le site internet pour obtenir des caractéristiques techniques à jour.

Les produits figurant dans ce catalogue sont MODÈLES DÉPOSÉS.

9010
novantadieci®

CONTACTS

Via Contessa, 23
36055 Nove VI - Italy
Tel. +39 0424 590388
Fax. +39 0424 829990

www.9010.it

Copywriter

9010 novantadieci

Printed

Marzo 2020